

**C.M.V.I. GROUP SRL** Via Fabrizio De Andrè, 95  
70026 Modugno (Ba) ITALY [www.cmvisrl.com](http://www.cmvisrl.com) [info@cmvisrl.com](mailto:info@cmvisrl.com)  
Tel.080/5358899 Fax 080/5358909

# Catalogo Generale

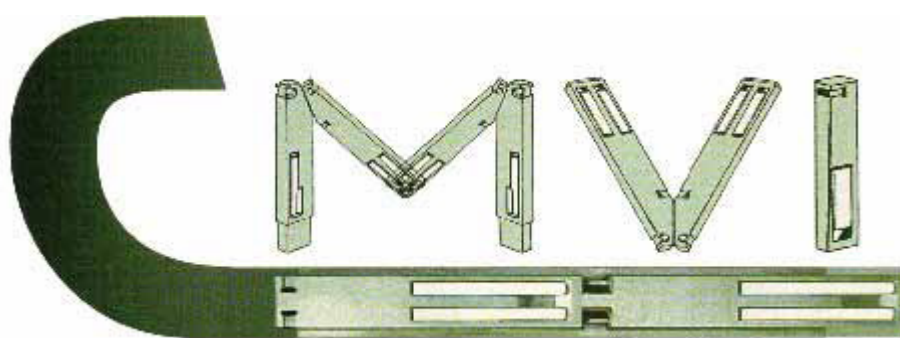

# 2010



S.P. 231 (Ex S.S. 98) Km. 79+850 - 70026 MODUGNO (BA)  
<http://www.cmvisrl.com> - email: [info@cmvisrl.com](mailto:info@cmvisrl.com)  
 Tel.: 080 - 5358899 - Fax: 080 - 5358909  
 P.IVA: 05329520729

INDICE

INDICE

	<b>Pagina</b>
Indice	2
Condizioni di vendita	5
Vista laterale	6
Vista dall'alto	7
<b>Montanti serie CMVI spessore 33 mm</b>	<b>8</b>
Montante rovesciabile fisso -- serie leggera	9
Montante rovesciabile fisso sganciabile	10
Montante rovesciabile fisso	11
Montante innesto fisso	16
Montante innesto ribaltabile -- serie leggera	18
Montante ribaltabile sfilabile smussato spessore 33 - 41 mm	20
Montante rovesciabile ribaltabile -- serie leggera	21
Montante ribaltabile fisso anteriore a saldare	23
Montante ribaltabile fisso anteriore a saldare -- serie leggera	24
Montante rovesciabile ribaltabile sganciabile	25
Montante rovesciabile ribaltabile	26
Montante rovesciabile ribaltabile -- 2 leve 1 chiusura	29
Montante rovesciabile ribaltabile -- 4 leve 2 chiusure	31
Montante anteriore largo sfilabile con innesto	33
Montante sfilabile ribaltabile	34
Montante sfilabile ribaltabile -- 2 leve 1 chiusura	37
Montante sfilabile ribaltabile -- 4 leve 2 chiusure	39
Montante rovesciabile sfilabile ribaltabile -- pari sopra	41
Montante rovesciabile sfilabile ribaltabile -- smussati	42
Montante rovesciabile fisso ribaltabile con snodo superiore	43
Montante sponda posteriore	44
Montante gran volume	45



S.P. 231 (Ex S.S. 98) Km. 79+850 - 70026 MODUGNO (BA)  
<http://www.cmvisrl.com> - email: [info@cmvisrl.com](mailto:info@cmvisrl.com)  
 Tel.: 080 - 5358899 - Fax: 080 - 5358909  
 P.IVA: 05329520729

INDICE

INDICE

	<b>Pagina</b>
<b>Montanti serie CMVI spessore mm. 41</b>	46
Montante rovesciabile fisso	47
Montante innesto fisso	52
Montante rovesciabile ribaltabile	54
Montante rovesciabile ribaltabile -- 4 leve 2 chiusure	57
Montante sfilabile ribaltabile	59
Montante sfilabile ribaltabile -- 4 leve 2 chiusure	62
Anteriore alto a saldare	64
Montante anteriore largo sfilabile con innesto	65
<b>Montanti serie CMVI spessore mm. 46</b>	66
Montante sfilabile ribaltabile	67
Montante innesto ribaltabile	68
Montante sfilabile ribaltabile 4 leve 2 chiusure	69
Anteriore alto a saldare	70
Montante anteriore largo sfilabile con innesto	71
<b>Sovramontanti serie CMVI</b>	72
Sovramontante tubolare Spessore 33 mm	73
Sovramontante a leva ribaltabile Spessore 33 mm—Speciale	76
Sovramontante a leva ribaltabile Spessore 33 mm	82
Sovramontante a leva ribaltabile -- 4 leve 2 chiusure Spessore 33 mm	85
Sovramontante a leva ribaltabile Spessore 41 mm	87
Sovramontante a leva ribaltabile -- 4 leve 2 chiusure Spessore 41 mm	90
Sovramontante a leva ribaltabile Spessore 46 mm	92
Sovramontante a leva ribaltabile -- 4 leve 2 chiusure Spessore 46 mm	94
Sovramontante a trilaterale 180° spessore 33 mm	95



S.P. 231 (Ex S.S. 98) Km. 79+850 - 70026 MODUGNO (BA)  
<http://www.cmvisrl.com> - email: [info@cmvisrl.com](mailto:info@cmvisrl.com)  
Tel.: 080 - 5358899 - Fax: 080 - 5358909  
P.IVA: 05329520729

CONDIZIONI DI VENDITA

## CONDIZIONI DI VENDITA

- A) Gli ordini sono accettati salvo approvazione della casa
- B) I termini di consegna stabiliti in commissione non possono costituire un impegno inderogabile per cui resta esclusa qualsiasi responsabilità della venditrice.
- C) La merce si intende viaggiare per conto e rischio del committente anche se venduta franco destino
- D) Resta convenuto che in ogni caso di responsabilità della ditta venditrice, il risarcimento del danno non potrà, complessivamente, mai superare il prezzo della merce venduta
- E) I pagamenti si effettuano alla scadenza convenuta direttamente alla sede della ditta venditrice. Sui pagamenti ritardati verranno calcolati gli interessi d'uso.
- F) Le descrizioni ed i prezzi del presente listino potranno essere modificati senza alcun preavviso.
- G) L'acquirente non potrà ritardare o sospendere i pagamenti per nessuna ragione; il mancato pagamento di una rata o di una fattura o l'affittanza o la vendita dell'azienda dell'acquirente determineranno la scadenza di tutto il debito e di tutte le fatture.
- H) L'I.V.A., i bolli delle tratte, delle cambiali e delle quietanze inerenti, nonché le spese d'incasso relative, quelle per il ritorno e la remissione delle tratte insolute, il ritorno insoluto delle Ri.ba., sono sempre a carico del committente.
- I) Non si accettano reclami trascorsi cinque giorni dal ricevimento della merce che si intende, dopo tale periodo, integralmente accettata.
- J) Per qualsiasi controversia unico Foro competente è quello di Modugno (BA).
- K) Nel caso di inadempienza della committente saranno a carico della medesima tutte le spese, nessuna esclusa, che la ditta venditrice incontrerà per indurre, anche in via amichevole e stragiudiziale, l'altra parte dell'adempimento degli obblighi assunti.
- L) Testi, disegni, grafica e quant'altro incluso in questo catalogo sono di proprietà esclusiva della società CMVI s.r.l. pertanto ne è vietata la riproduzione in qualsiasi forma.



S.P. 231 (Ex S.S. 98) Km. 79+850 - 70026 MODUGNO (BA)  
<http://www.cmvisrl.com> - email: [info@cmvisrl.com](mailto:info@cmvisrl.com)  
Tel.: 080 - 5358899 - Fax: 080 - 5358909  
P.IVA: 05329520729

VISTE

VISTA DALL'ALTO

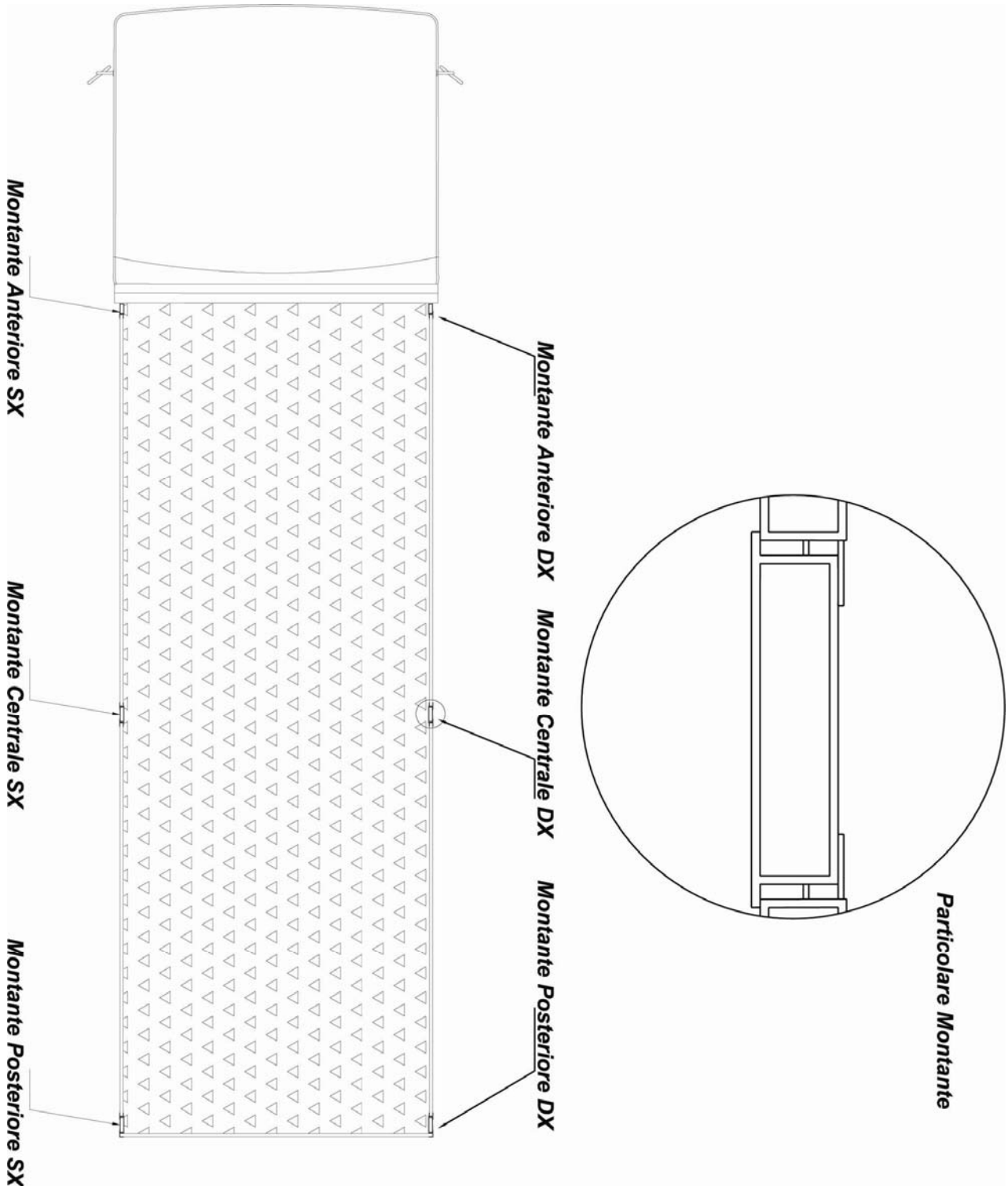

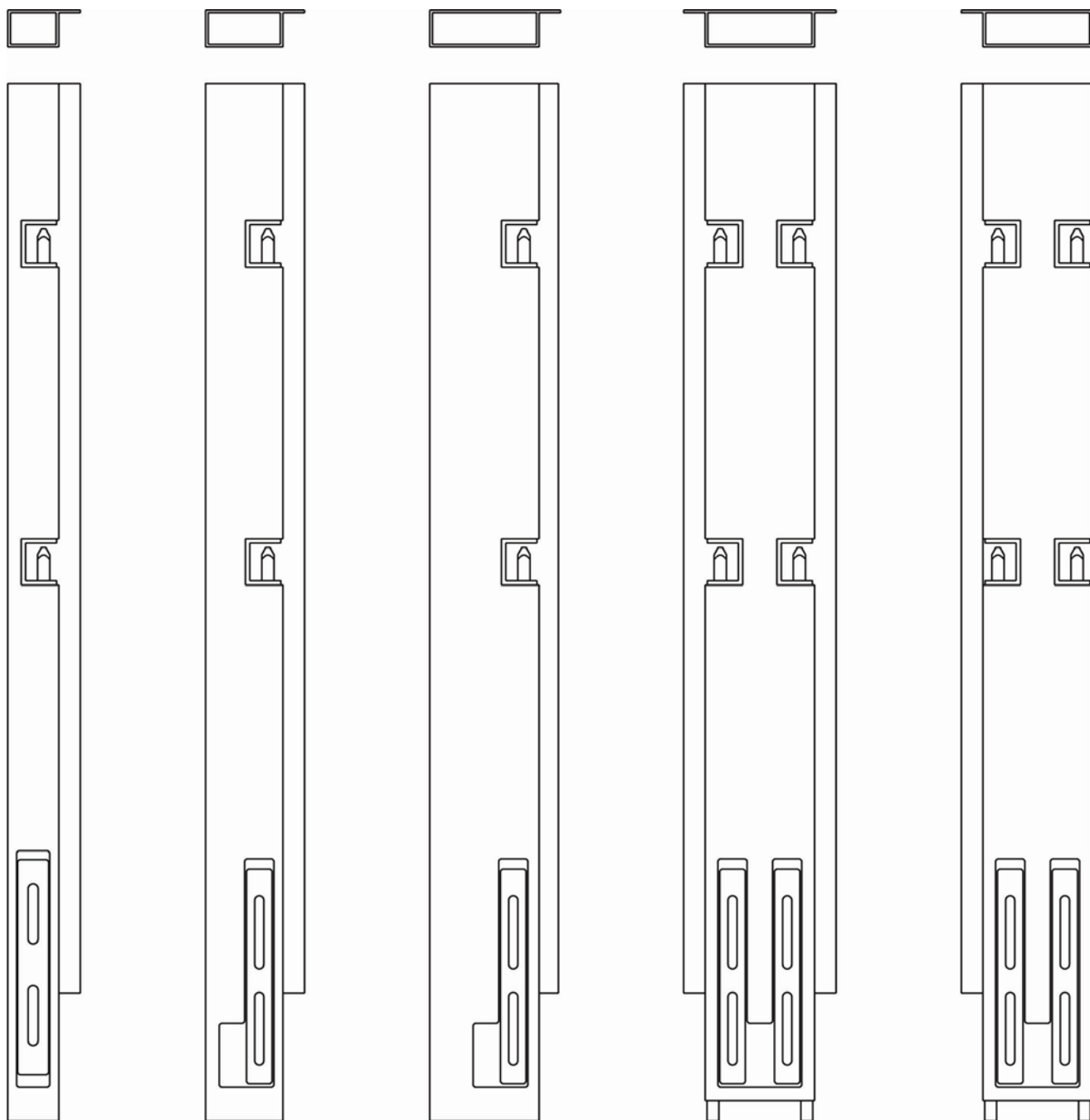

MONTANTI SERIE CMVI SPESSORE mm 33



S.P. 231 (Ex S.S. 98) Km. 79+850 - 70026 MODUGNO (BA)  
 http://www.cmvisrl.com - email: info@cmvisrl.com  
 Tel.: 080 - 5358899 - Fax: 080 - 5358909  
 P.IVA: 05329520729

**MONTANTI**

## MONTANTE ROVESCIBILE FISSO Spessore mm 33

SERIE LEGGERA

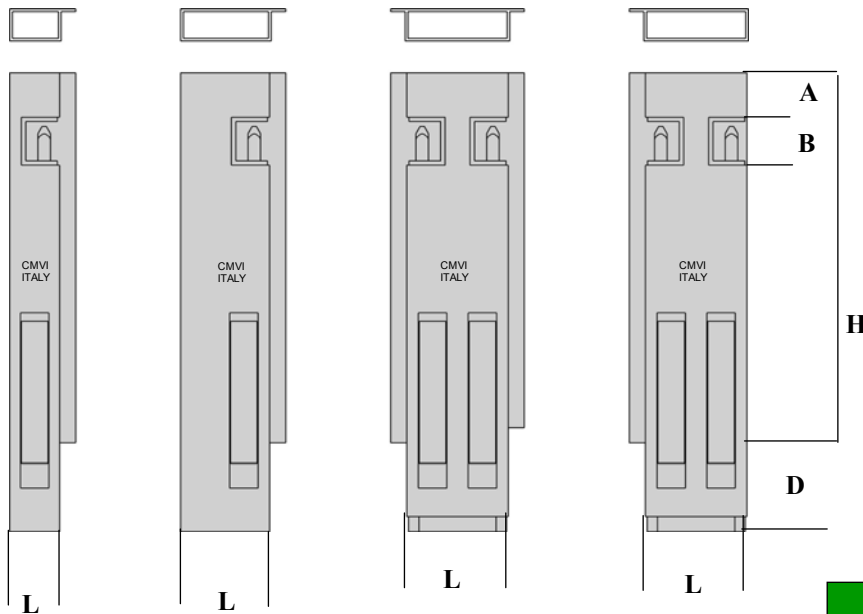

### Caratteristiche Tecniche

H.	A	B	D		
400	50	55	100		
500	150	55	100		

FERRO	INOX 304 PARZIALE	INOX 304 P. FIORET.			DESCRIZIONE	H.	L.	PESO gr
E040278D	E060278D	E060278DF			Anteriore DX	400	56	
E040278S	E060278S	E060278SF			Anteriore SX	400	56	
E040279D	E060279D	E060279DF			Anteriore DX	400	100	
E040279S	E060279S	E060279SF			Anteriore SX	400	100	
E040280	E060280	E060280F			Centrale	400	100	
E040281D	E060281D	E060281DF			Posteriore DX	400	100	
E040281S	E060281S	E060281SF			Posteriore SX	400	100	

E040282D	E060282D	E060282DF			Anteriore DX	500	56	
E040282S	E060282S	E060282SF			Anteriore SX	500	56	
E040283D	E060283D	E060283DF			Anteriore DX	500	100	
E040283S	E060283S	E060283SF			Anteriore SX	500	100	
E040284	E060284	E060284F			Centrale	500	100	
E040285D	E060285D	E060285DF			Posteriore DX	500	100	
E040285S	E060285S	E060285SF			Posteriore SX	500	100	



S.P. 231 (Ex S.S. 98) Km. 79+850 - 70026 MODUGNO (BA)  
<http://www.cmvisrl.com> - email: [info@cmvisrl.com](mailto:info@cmvisrl.com)  
 Tel.: 080 - 5358899 - Fax: 080 - 5358909  
 P.IVA: 05329520729

**MONTANTI**

**MONTANTE ROVESCIBILE FISSO SGANCIABILE**  
**SPESSORE mm 33**

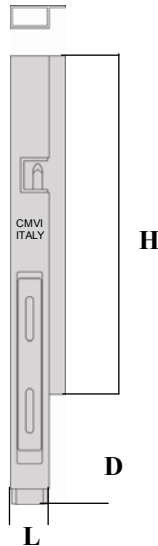

FERRO	INOX 304 PARZIALE	INOX 304 TOTALE	INOX 304 P. FIORET.	INOX 304 T. FIORET.				
CODICE	CODICE	CODICE	CODICE	CODICE	DESCRIZIONE	H.	L.	D
E010350D	E020350D	E030350D	E020350DF	E030350DF	Anteriore DX	400	56	140
E010350S	E020350S	E030350S	E020350SF	E030350SF	Anteriore SX	400	56	140
E010351D	E020351D	E030351D	E020351DF	E030351DF	Anteriore DX	500	56	140
E010351S	E020351S	E030351S	E020351SF	E030351SF	Anteriore SX	500	56	140
E010352D	E020352D	E030352D	E020352DF	E030352DF	Anteriore DX	600	56	140
E010352S	E020352S	E030352S	E020352SF	E030352SF	Anteriore SX	600	56	140
E010353D	E020353D	E030353D	E020353DF	E030353DF	Anteriore DX	700	56	140
E010353S	E020353S	E030353S	E020353SF	E030353SF	Anteriore SX	700	56	140
E010354D	E020354D	E030354D	E020354DF	E030354DF	Anteriore DX	800	56	140
E010354S	E020354S	E030354S	E020354SF	E030354SF	Anteriore SX	800	56	140
E010355D	E020355D	E030355D	E020355DF	E030355DF	Anteriore DX	900	56	140
E010355S	E020355S	E030355S	E020355SF	E030355SF	Anteriore SX	900	56	140
E010356D	E020356D	E030356D	E020356DF	E030356DF	Anteriore DX	1000	56	140
E010356S	E020356S	E030356S	E020356SF	E030356SF	Anteriore SX	1000	56	140
E010357D	E020357D	E030357D	E020357DF	E030357DF	Anteriore DX	1100	56	140
E010357S	E020357S	E030357S	E020357SF	E030357SF	Anteriore SX	1100	56	140
E010358D	E020358D	E030358D	E020358DF	E030358DF	Anteriore DX	1200	56	140
E010358S	E020358S	E030358S	E020358SF	E030358SF	Anteriore SX	1200	56	140





S.P. 231 (Ex S.S. 98) Km. 79+850 - 70026 MODUGNO (BA)  
 http://www.cmvisrl.com - email: info@cmvisrl.com  
 Tel.: 080 - 5358899 - Fax: 080 - 5358909  
 P.IVA: 05329520729

**MONTANTI**

**MONTANTE ROVESCIBILE FISSO**

**Spessore mm 33**

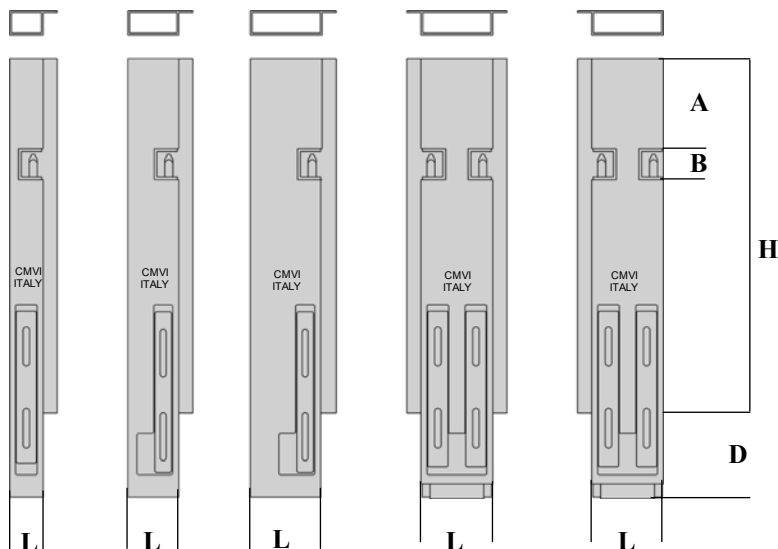

**Caratteristiche Tecniche**

H.	A	B	D		
400	50	55	140		
500	150	55	140		

FERRO	INOX 304 PARZIALE	INOX 304 TOTALE	INOX 304 P. FIORET.	INOX 304 T. FIORET.	DESCRIZIONE	H.	L.	Peso gr
E010297D	E020297D	E030297D	E020297DF	E030297DF	Anteriore DX	400	56	
E010297S	E020297S	E030297S	E020297SF	E030297SF	Anteriore SX	400	56	
E010298D	E020298D	E030298D	E020298DF	E030298DF	Anteriore DX	400	85	
E010298S	E020298S	E030298S	E020298SF	E030298SF	Anteriore SX	400	85	
E010299D	E020299D	E030299D	E020299DF	E030299DF	Anteriore DX	400	120	
E010299S	E020299S	E030299S	E020299SF	E030299SF	Anteriore SX	400	120	
E010300	E020300	E030300	E020300F	E030300F	Centrale	400	120	
E010301D	E020301D	E030301D	E020301DF	E030301DF	Posteriore DX	400	120	
E010301S	E020301S	E030301S	E020301SF	E030301SF	Posteriore SX	400	120	

E010302D	E020302D	E030302D	E020302DF	E030302DF	Anteriore DX	500	56	
E010302S	E020302S	E030302S	E020302SF	E030302SF	Anteriore SX	500	56	
E010303D	E020303D	E030303D	E020303DF	E030303DF	Anteriore DX	500	85	
E010303S	E020303S	E030303S	E020303SF	E030303SF	Anteriore SX	500	85	
E010304D	E020304D	E030304D	E020304DF	E030304DF	Anteriore DX	500	120	
E010304S	E020304S	E030304S	E020304SF	E030304SF	Anteriore SX	500	120	
E010305	E020305	E030305	E020305F	E030305F	Centrale	500	120	
E010306D	E020306D	E030306D	E020306DF	E030306DF	Posteriore DX	500	120	
E010306S	E020306S	E030306S	E020306SF	E030306SF	Posteriore SX	500	120	



S.P. 231 (Ex S.S. 98) Km. 79+850 - 70026 MODUGNO (BA)  
 http://www.cmvisrl.com - email: info@cmvisrl.com  
 Tel.: 080 - 5358899 - Fax: 080 - 5358909  
 P.IVA: 05329520729

MONTANTI

## MONTANTE ROVESCIBILE FISSO

### Spessore mm 33

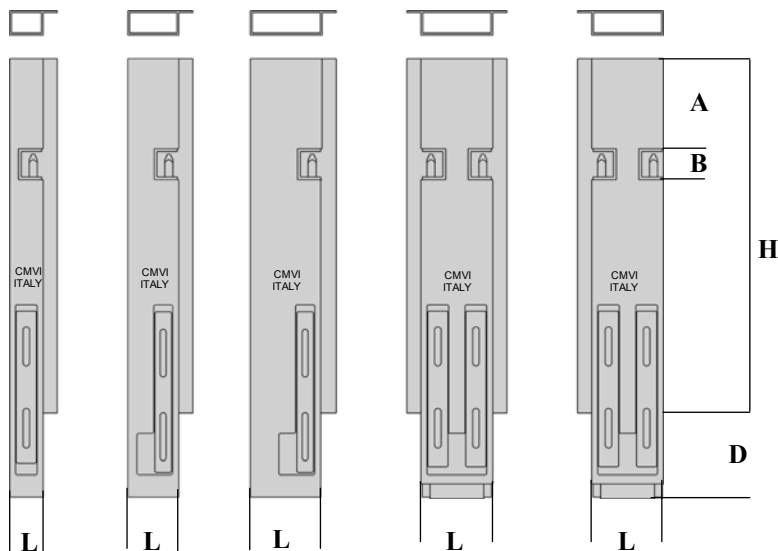

#### Caratteristiche Tecniche

H.	A	B	D		
600	50	55	140		
700	150	55	140		

FERRO	INOX 304 PARZIALE	INOX 304 TOTALE	INOX 304 P. FIORET.	INOX 304 T. FIORET.	DESCRIZIONE	H.	L.	Peso gr
<b>E010308D</b>	<b>E020308D</b>	<b>E030308D</b>	<b>E020308DF</b>	<b>E030308DF</b>	Anteriore DX	<b>600</b>	<b>56</b>	
<b>E010308S</b>	<b>E020308S</b>	<b>E030308S</b>	<b>E020308SF</b>	<b>E030308SF</b>	Anteriore SX	<b>600</b>	<b>56</b>	
<b>E010309D</b>	<b>E020309D</b>	<b>E030309D</b>	<b>E020309DF</b>	<b>E030309DF</b>	Anteriore DX	<b>600</b>	<b>85</b>	
<b>E010309S</b>	<b>E020309S</b>	<b>E030309S</b>	<b>E020309SF</b>	<b>E030309SF</b>	Anteriore SX	<b>600</b>	<b>85</b>	
<b>E010310D</b>	<b>E020310D</b>	<b>E030310D</b>	<b>E020310DF</b>	<b>E030310DF</b>	Anteriore DX	<b>600</b>	<b>120</b>	
<b>E010310S</b>	<b>E020310S</b>	<b>E030310S</b>	<b>E020310SF</b>	<b>E030310SF</b>	Anteriore SX	<b>600</b>	<b>120</b>	
<b>E010311</b>	<b>E020311</b>	<b>E030311</b>	<b>E020311F</b>	<b>E030311F</b>	Centrale	<b>600</b>	<b>120</b>	
<b>E010312D</b>	<b>E020312D</b>	<b>E030312D</b>	<b>E020312DF</b>	<b>E030312DF</b>	Posteriore DX	<b>600</b>	<b>120</b>	
<b>E010312S</b>	<b>E020312S</b>	<b>E030312S</b>	<b>E020312SF</b>	<b>E030312SF</b>	Posteriore SX	<b>600</b>	<b>120</b>	

<b>E009314D</b>	<b>E019314D</b>	<b>E029314D</b>	<b>E019314DF</b>	<b>E029314DF</b>	Anteriore DX	<b>700</b>	<b>56</b>	
<b>E009314S</b>	<b>E019314S</b>	<b>E029314S</b>	<b>E019314SF</b>	<b>E029314SF</b>	Anteriore SX	<b>700</b>	<b>56</b>	
<b>E009315D</b>	<b>E019315D</b>	<b>E029315D</b>	<b>E019315DF</b>	<b>E029315DF</b>	Anteriore DX	<b>700</b>	<b>85</b>	
<b>E009315S</b>	<b>E019315S</b>	<b>E029315S</b>	<b>E019315SF</b>	<b>E029315SF</b>	Anteriore SX	<b>700</b>	<b>85</b>	
<b>E009316D</b>	<b>E019316D</b>	<b>E029316D</b>	<b>E019316DF</b>	<b>E029316DF</b>	Anteriore DX	<b>700</b>	<b>120</b>	
<b>E009316S</b>	<b>E019316S</b>	<b>E029316S</b>	<b>E019316SF</b>	<b>E029316SF</b>	Anteriore SX	<b>700</b>	<b>120</b>	
<b>E009317</b>	<b>E019317</b>	<b>E029317</b>	<b>E019317F</b>	<b>E029317F</b>	Centrale	<b>700</b>	<b>120</b>	
<b>E009318D</b>	<b>E019318D</b>	<b>E029318D</b>	<b>E019318DF</b>	<b>E029318DF</b>	Posteriore DX	<b>700</b>	<b>120</b>	
<b>E009318S</b>	<b>E019318S</b>	<b>E029318S</b>	<b>E019318SF</b>	<b>E029318SF</b>	Posteriore SX	<b>700</b>	<b>120</b>	



S.P. 231 (Ex S.S. 98) Km. 79+850 - 70026 MODUGNO (BA)  
<http://www.cmvisrl.com> - email: [info@cmvisrl.com](mailto:info@cmvisrl.com)  
 Tel.: 080 - 5358899 - Fax: 080 - 5358909  
 P.IVA: 05329520729

**MONTANTI**

**MONTANTE ROVESCIBILE FISSO**

**Spessore mm 33**

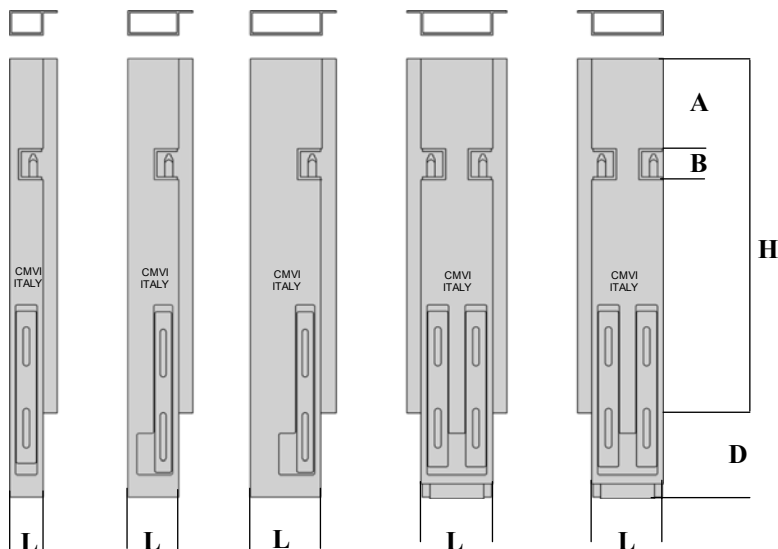

**Caratteristiche Tecniche**

H.	A	B	D		
800	150	55	140		
900	150	55	140		

FERRO	INOX 304 PARZIALE	INOX 304 TOTALE	INOX 304 P. FIORET.	INOX 304 T. FIORET.	DESCRIZIONE	H.	L.	Peso gr
<b>E010314D</b>	<b>E020314D</b>	<b>E030314D</b>	<b>E020314DF</b>	<b>E030314DF</b>	Anteriore DX	<b>800</b>	<b>56</b>	
<b>E010314S</b>	<b>E020314S</b>	<b>E030314S</b>	<b>E020314SF</b>	<b>E030314SF</b>	Anteriore SX	<b>800</b>	<b>56</b>	
<b>E010315D</b>	<b>E020315D</b>	<b>E030315D</b>	<b>E020315DF</b>	<b>E030315DF</b>	Anteriore DX	<b>800</b>	<b>85</b>	
<b>E010315S</b>	<b>E020315S</b>	<b>E030315S</b>	<b>E020315SF</b>	<b>E030315SF</b>	Anteriore SX	<b>800</b>	<b>85</b>	
<b>E010316D</b>	<b>E020316D</b>	<b>E030316D</b>	<b>E020316DF</b>	<b>E030316DF</b>	Anteriore DX	<b>800</b>	<b>120</b>	
<b>E010316S</b>	<b>E020316S</b>	<b>E030316S</b>	<b>E020316SF</b>	<b>E030316SF</b>	Anteriore SX	<b>800</b>	<b>120</b>	
<b>E010317</b>	<b>E020317</b>	<b>E030317</b>	<b>E020317F</b>	<b>E030317F</b>	Centrale	<b>800</b>	<b>120</b>	
<b>E010318D</b>	<b>E020318D</b>	<b>E030318D</b>	<b>E020318DF</b>	<b>E030318DF</b>	Posteriore DX	<b>800</b>	<b>120</b>	
<b>E010318S</b>	<b>E020318S</b>	<b>E030318S</b>	<b>E020318SF</b>	<b>E030318SF</b>	Posteriore SX	<b>800</b>	<b>120</b>	

<b>E009320D</b>	<b>E019320D</b>	<b>E029320D</b>	<b>E019320DF</b>	<b>E029320DF</b>	Anteriore DX	<b>900</b>	<b>56</b>	
<b>E009320S</b>	<b>E019320S</b>	<b>E029320S</b>	<b>E019320SF</b>	<b>E029320SF</b>	Anteriore SX	<b>900</b>	<b>56</b>	
<b>E009321D</b>	<b>E019321D</b>	<b>E029321D</b>	<b>E019321DF</b>	<b>E029321DF</b>	Anteriore DX	<b>900</b>	<b>85</b>	
<b>E009321S</b>	<b>E019321S</b>	<b>E029321S</b>	<b>E019321SF</b>	<b>E029321SF</b>	Anteriore SX	<b>900</b>	<b>85</b>	
<b>E009322D</b>	<b>E019322D</b>	<b>E029322D</b>	<b>E019322DF</b>	<b>E029322DF</b>	Anteriore DX	<b>900</b>	<b>120</b>	
<b>E009322S</b>	<b>E019322S</b>	<b>E029322S</b>	<b>E019322SF</b>	<b>E029322SF</b>	Anteriore SX	<b>900</b>	<b>120</b>	
<b>E009323</b>	<b>E019323</b>	<b>E029323</b>	<b>E019323F</b>	<b>E029323F</b>	Centrale	<b>900</b>	<b>120</b>	
<b>E009324D</b>	<b>E019324D</b>	<b>E029324D</b>	<b>E019324DF</b>	<b>E029324DF</b>	Posteriore DX	<b>900</b>	<b>120</b>	
<b>E009324S</b>	<b>E019324S</b>	<b>E029324S</b>	<b>E019324SF</b>	<b>E029324SF</b>	Posteriore SX	<b>900</b>	<b>120</b>	

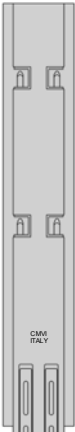

CMM  
ITALY



S.P. 231 (Ex S.S. 98) Km. 79+850 - 70026 MODUGNO (BA)  
<http://www.cmvisrl.com> - email: [info@cmvisrl.com](mailto:info@cmvisrl.com)  
 Tel.: 080 - 5358899 - Fax: 080 - 5358909  
 P.IVA: 05329520729

**MONTANTI**

## MONTANTE ROVESCIBILE FISSO

### Spessore mm 33

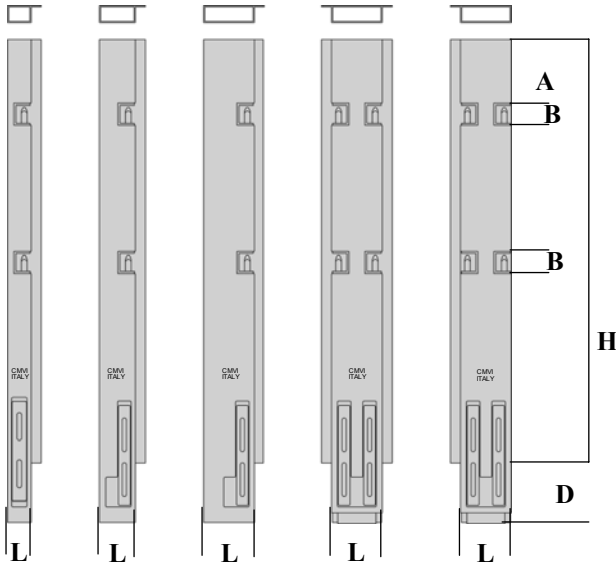

#### Caratteristiche Tecniche

H.	A	B	D		
1200	150	55	140		

FERRO	INOX 304 PARZIALE	INOX 304 TOTALE	INOX 304 P. FIORET.	INOX 304 T. FIORET.	DESCRIZIONE	H.	L.	PESO gr
E010332D	E020332D	E030332D	E020332DF	E030332DF	Anteriore DX	1200	56	
E010332S	E020332S	E030332S	E020332SF	E030332SF	Anteriore SX	1200	56	
E010333D	E020333D	E030333D	E020333DF	E030333DF	Anteriore DX	1200	85	
E010333S	E020333S	E030333S	E020333SF	E030333SF	Anteriore SX	1200	85	
E010334D	E020334D	E030334D	E020334DF	E030334DF	Anteriore DX	1200	120	
E010334S	E020334S	E030334S	E020334SF	E030334SF	Anteriore SX	1200	120	
E010335	E020335	E030335	E020335F	E030335F	Centrale	1200	120	
E010336D	E020336D	E030336D	E020336DF	E030336DF	Posteriore DX	1200	120	
E010336S	E020336S	E030336S	E020336SF	E030336SF	Posteriore SX	1200	120	





S.P. 231 (Ex S.S. 98) Km. 79+850 - 70026 MODUGNO (BA)  
 http://www.cmvisrl.com - email: info@cmvisrl.com  
 Tel.: 080 - 5358899 - Fax: 080 - 5358909  
 P.IVA: 05329520729

MONTANTI

MONTANTE INNESTO FISSO

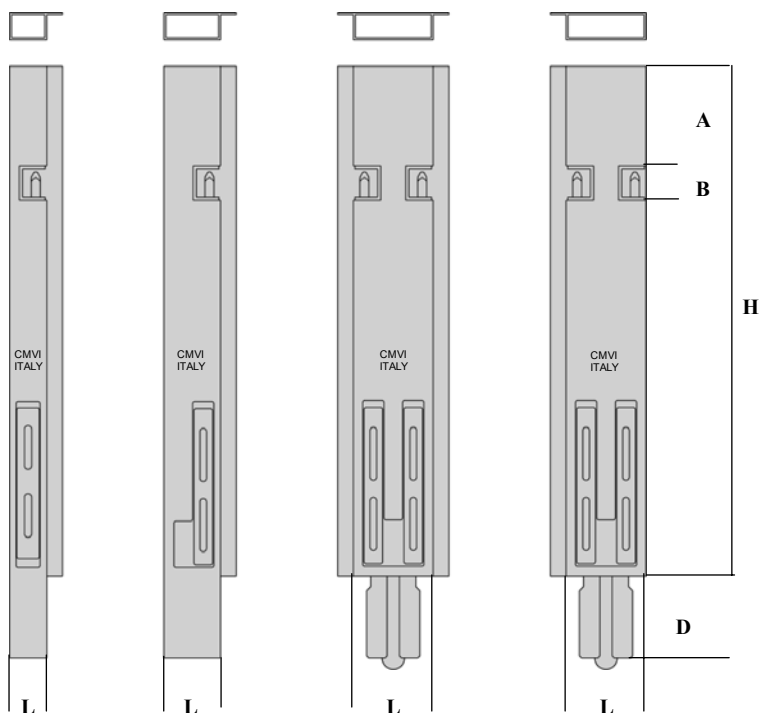
**Spessore mm 33**



**Caratteristiche Tecniche**

H.	A	B	D		
600	150	55	140		
800	150	55	140		

FERRO	INOX 304 PARZIALE	INOX 304* TOTALE	INOX 304 P. FIORET.	INOX 304 T. FIORET.				
CODICE	CODICE	CODICE	CODICE	CODICE	DESCRIZIONE	H.	L.	PESO gr
F010338D	F020338D	F030338D	F020338DF	F030338DF	Anteriore DX	600	56	
F010338S	F020338S	F030338S	F020338SF	F030338SF	Anteriore SX	600	56	
F010339D	F020339D	F030339D	F020339DF	F030339DF	Anteriore DX	600	85	
F010339S	F020339S	F030339S	F020339SF	F030339SF	Anteriore SX	600	85	
F010340	F020340	F030340	F020340F	F030340F	Centrale	600	120	
F010341D	F020341D	F030341D	F020341DF	F030341DF	Posteriore DX	600	120	
F010341S	F020341S	F030341S	F020341SF	F030341SF	Posteriore SX	600	120	

F010342D	F020342D	F030342D	F020342DF	F030342DF	Anteriore DX	800	56	
F010342S	F020342S	F030342S	F020342SF	F030342SF	Anteriore SX	800	56	
F010343D	F020343D	F030343D	F020343DF	F030343DF	Anteriore DX	800	85	
F010343S	F020343S	F030343S	F020343SF	F030343SF	Anteriore SX	800	85	
F010344	F020344	F030344	F020344F	F030344F	Centrale	800	120	
F010345D	F020345D	F030345D	F020345DF	F030345DF	Posteriore DX	800	120	
F010345S	F020345S	F030345S	F020345SF	F030345SF	Posteriore SX	800	120	

\* N.B. Il montante ad innesto totalmente inox è fornito con la sede e l'innesto in FERRO.  
 Per la sede e l'innesto inox chiedere la differenza al momento dell'ordine



S.P. 231 (Ex S.S. 98) Km. 79+850 - 70026 MODUGNO (BA)  
 http://www.cmvisrl.com - email: info@cmvisrl.com  
 Tel.: 080 - 5358899 - Fax: 080 - 5358909  
 P.IVA: 05329520729

MONTANTI

MONTANTE INNESTO FISSO

**Spessore mm 33**

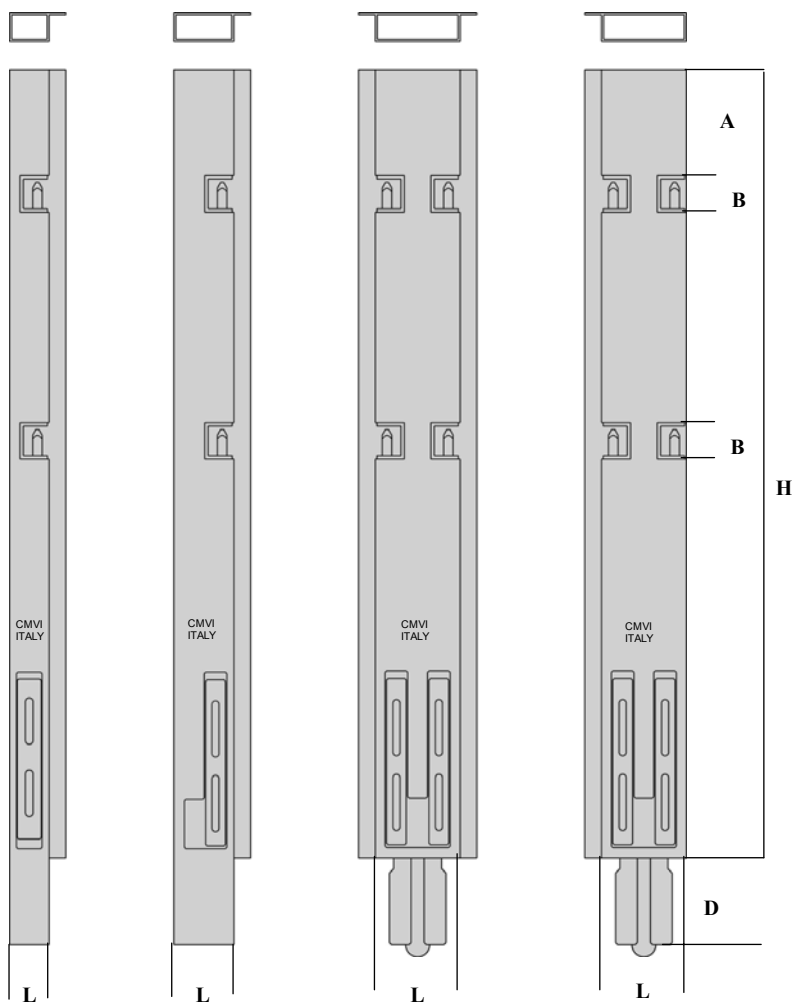

**Caratteristiche Tecniche**

H.	A	B	D		
1000	120	55	140		

FERRO	INOX 304 PARZIALE	INOX 304* TOTALE	INOX 304 P. FIORET.	INOX 304 T. FIORET.	DESCRIZIONE	H.	L.	PESO gr
F010346D	F020346D	F030346D	F020346DF	F030346DF	Anteriore DX	1000	56	
F010346S	F020346S	F030346S	F020346SF	F030346SF	Anteriore SX	1000	56	
F010347D	F020347D	F030347D	F020347DF	F030347DF	Anteriore DX	1000	120	
F010347S	F020347S	F030347S	F020347SF	F030347SF	Anteriore SX	1000	120	
F010348	F020348	F030348	F020348F	F030348F	Centrale	1000	120	
F010349D	F020349D	F030349D	F020349DF	F030349DF	Posteriore DX	1000	120	
F010349S	F020349S	F030349S	F020349SF	F030349SF	Posteriore SX	1000	120	

\* N.B. Il montante ad innesto totalmente inox è fornito con la sede e l'innesto in FERRO.  
 Per la sede e l'innesto inox chiedere la differenza al momento dell'ordine



S.P. 231 (Ex S.S. 98) Km. 79+850 - 70026 MODUGNO (BA)  
 http://www.cmvisrl.com - email: info@cmvisrl.com  
 Tel.: 080 - 5358899 - Fax: 080 - 5358909  
 P.IVA: 05329520729

MONTANTI

MONTANTE INNESTO RIBALTABILE  
**Spessore mm 33**

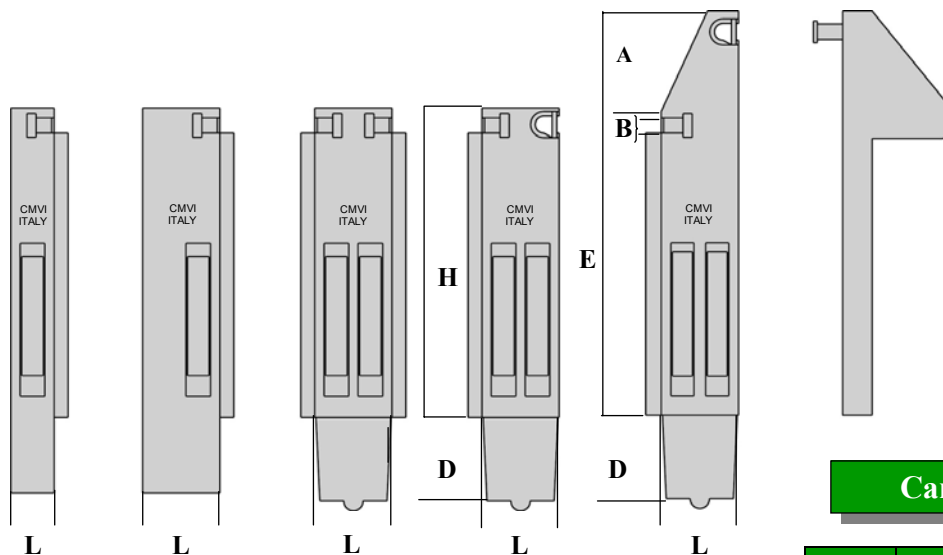

SERIE LEGGERA

**Caratteristiche Tecniche**

H.	A	B	D	E	
400	125	30	100	525	

FERRO	INOX 304 PARZIALE	INOX 304 TOTALE	INOX 304 P. FIORET.	INOX 304 T. FIORET.	DESCRIZIONE	H.	L.	PESO gr
CODICE	CODICE	CODICE	CODICE	CODICE				
C010244D	C016244D	C012244D	C016244DF	C012244DF	Anteriore DX	400	56	
C010244S	C016244S	C012244S	C016244SF	C012244SF	Anteriore SX	400	56	
C010245D	C016245D	C012245D	C016245DF	C012245DF	Anteriore DX	400	100	
C010245S	C016245S	C012245S	C016245SF	C012245SF	Anteriore SX	400	100	
C010246	C016246	C012246	C016246F	C012246F	Centrale	400	100	
C011246D	C016247D	C013246D	C016247DF	C013246DF	Posteriore DX	400	100	
C011246S	C016247S	C013246S	C016247SF	C013246SF	Posteriore SX	400	100	
C010247D	C016248D	C011247D	C016248DF	C012247DF	Posteriore DX	400/525	100	
C010247S	C016248S	C011247S	C016248SF	C012247SF	Posteriore SX	400/525	100	

I010687		I020687		I020687F	Testata smussata sp.25	525		





S.P. 231 (Ex S.S. 98) Km. 79+850 - 70026 MODUGNO (BA)  
<http://www.cmvisrl.com> - email: [info@cmvisrl.com](mailto:info@cmvisrl.com)  
 Tel.: 080 - 5358899 - Fax: 080 - 5358909  
 P.IVA: 05329520729

MONTANTI

## MONTANTE INNESTO RIBALTABILE

### Spessore mm 33

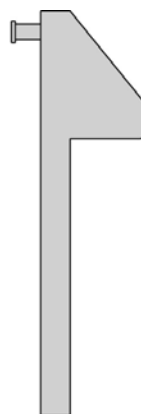
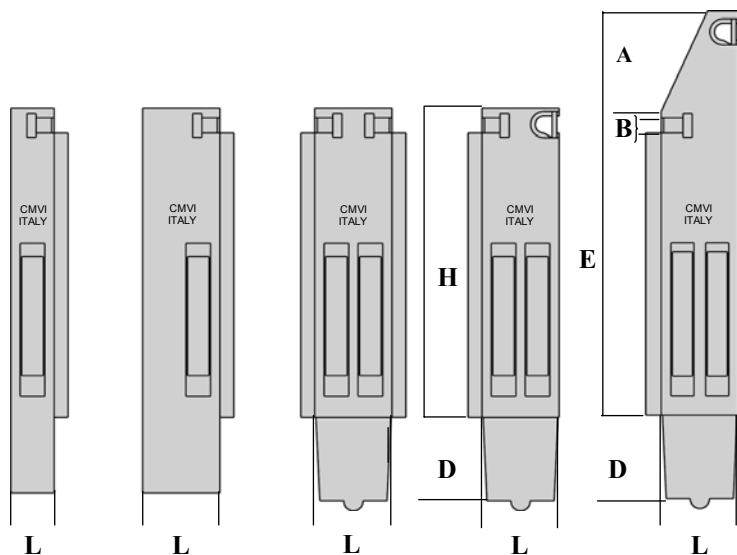

SERIE LEGGERA

#### Caratteristiche Tecniche

H.	A	B	D	E	
500	125	30	100	525	

FERRO	INOX 304 PARZIALE	INOX 304 TOTALE	INOX 304 P. FIORET.	INOX 304 T. FIORET.	DESCRIZIONE	H.	L.	PESO gr
CODICE	CODICE	CODICE	CODICE	CODICE				
C010248D	C017248D	C012248D	C017248DF	C012248DF	Anteriore DX	500	56	
C010248S	C017248S	C012248S	C017248SF	C012248SF	Anteriore SX	500	56	
C010249D	C017249D	C012249D	C017249DF	C012249DF	Anteriore DX	500	100	
C010249S	C017249S	C012249S	C017249SF	C012249SF	Anteriore SX	500	100	
C010250	C017250	C012250	C017250F	C012250F	Centrale	500	100	
C011250D	C017251D	C013250D	C017251DF	C013250DF	Posteriore DX	500	100	
C011250S	C017251S	C013250S	C017251SF	C013250SF	Posteriore SX	500	100	
C010251D	C017252D	C012251D	C017252DF	C012251DF	Posteriore DX	500/625	100	
C010251S	C017252C	C012251S	C017252C	C012251SF	Posteriore SX	500/625	100	

I010688		I020688		I020688F	Testata smussata s.25	625		



S.P. 231 (Ex S.S. 98) Km. 79+850 - 70026 MODUGNO (BA)  
<http://www.cmvisrl.com> - email: [info@cmvisrl.com](mailto:info@cmvisrl.com)  
 Tel.: 080 - 5358899 - Fax: 080 - 5358909  
 P.IVA: 05329520729

**MONTANTI**

**MONTANTE RIBALTABILE SFILABILE  
 SMUSSATO Spessore mm 33 - 41**

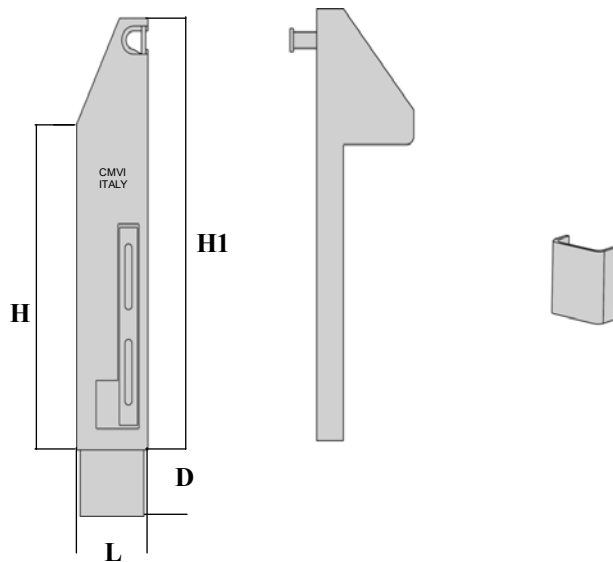

**Caratteristiche Tecniche**

H.	H1	D			
400	525	80			
500	625	80			

FERRO							
CODICE				DESCRIZIONE	H.	L.	PESO gr
C010276				Post. Sp.33	525	85	
C010277				Post. Sp.33	625	85	
C011276				Post. Sp.41	525	85	
C011277				Post. Sp.41	625	85	
C012276				Post. Sp.33	525	100	
C012277				Post. Sp.33	625	100	
C013276				Post. Sp.41	525	100	
C013277				Post. Sp.41	625	100	
C014276				Post. Sp.33	525	120	
C014277				Post. Sp.33	625	120	
C015276				Post. Sp.41	525	120	
C015277				Post. Sp.41	625	120	
I010687				Testata Zinc. 25 mm	525		
I010688				Testata Zinc. 25 mm	625		



S.P. 231 (Ex S.S. 98) Km. 79+850 - 70026 MODUGNO (BA)  
 http://www.cmvisrl.com - email: info@cmvisrl.com  
 Tel.: 080 - 5358899 - Fax: 080 - 5358909  
 P.IVA: 05329520729

**MONTANTI**

**MONTANTE ROVESCIBILE RIBALTABILE**  
**Spessore mm 33**

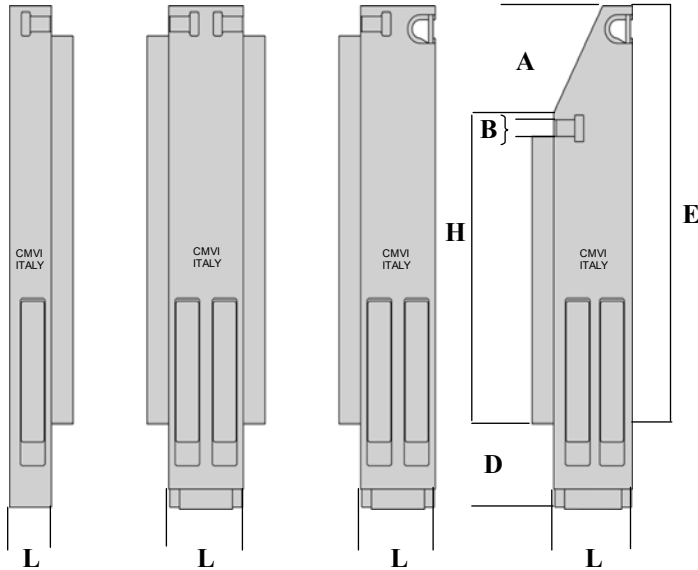

**SERIE LEGGERA**

**Caratteristiche Tecniche**

H.	A	B	D	E	
300	125	30	100	425	
350	125	30	100	475	

FERRO	INOX 304 PARZIALE	INOX 304 TOTALE	INOX 304 P. FIORET.	INOX 304 T. FIORET.	DESCRIZIONE	H.	L.	PESO gr
A010084D	A020084D	A030084D	A020084DF	A030084DF	Anteriore DX	300	56	
A010084S	A020084S	A030084S	A020084SF	A030084SF	Anteriore SX	300	56	
A010085D	A020085D	A030085D	A020085DF	A030085DF	Anteriore DX	300	100	
A010085S	A020085S	A030085S	A020085SF	A030085SF	Anteriore SX	300	100	
A010086	A020086	A030086	A020086F	A030086F	Centrale	300	100	
A010087D	A020087D	A030087D	A020087DF	A030087DF	Posteriore DX	300	100	
A010087S	A020087S	A030087S	A020087SF	A030087SF	Posteriore SX	300	100	
A010080D	A020080D	A030080D	A020080DF	A030080DF	Posteriore DX	300/425	100	
A010080S	A020080S	A030080S	A020080SF	A030080SF	Posteriore SX	300/425	100	

A010088D	A020088D	A030088D	A020088DF	A030088DF	Anteriore DX	350	56	
A010088S	A020088S	A030088S	A020088SF	A030088SF	Anteriore SX	350	56	
A010089D	A020089D	A030089D	A020089DF	A030089DF	Anteriore DX	350	100	
A010089S	A020089S	A030089S	A020089SF	A030089SF	Anteriore SX	350	100	
A010090	A020090	A030090	A020090F	A030090F	Centrale	350	100	
A010091D	A020091D	A030091D	A020091DF	A030091DF	Posteriore DX	350	100	
A010091S	A020091S	A030091S	A020091SF	A030091SF	Posteriore SX	350	100	
A010081D	A020081D	A030081D	A020081DF	A030081DF	Posteriore DX	350/475	100	
A010081S	A020081S	A030081S	A020081SF	A030081SF	Posteriore SX	350/475	100	



S.P. 231 (Ex S.S. 98) Km. 79+850 - 70026 MODUGNO (BA)  
 http://www.cmvisrl.com - email: info@cmvisrl.com  
 Tel.: 080 - 5358899 - Fax: 080 - 5358909  
 P.IVA: 05329520729

**MONTANTI**

**MONTANTE ROVESCIBILE RIBALTABILE**  
**Spessore mm 33**

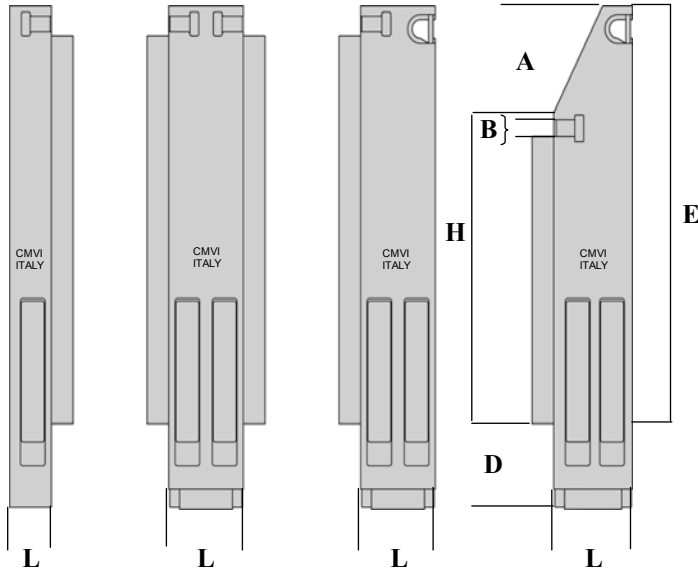

SERIE LEGGERA

**Caratteristiche Tecniche**

H.	A	B	D	E	
400	125	30	100	475	
500	125	30	100	525	

FERRO	INOX 304 PARZIALE	INOX 304 TOTALE	INOX 304 P. FIORET.	INOX 304 T. FIORET.				
CODICE	CODICE	CODICE	CODICE	CODICE	DESCRIZIONE	H.	L.	PESO gr
A010092D	A020092D	A030092D	A020092DF	A030092DF	Anteriore DX	400	56	
A010092S	A020092S	A030092S	A020092SF	A030092SF	Anteriore SX	400	56	
A010093D	A020093D	A030093D	A020093DF	A030093DF	Anteriore DX	400	100	
A010093S	A020093S	A030093S	A020093SF	A030093SF	Anteriore SX	400	100	
A010094	A020094	A030094	A020094F	A030094F	Centrale	400	100	
A010095D	A020095D	A030095D	A020095DF	A030095DF	Posteriore DX	400	100	
A010095S	A020095S	A030095S	A020095SF	A030095SF	Posteriore SX	400	100	
A010082D	A020082D	A030082D	A020082DF	A030082DF	Posteriore DX	400/525	100	
A010082S	A020082S	A030082S	A020082SF	A030082SF	Posteriore SX	400/525	100	

A010096D	A020096D	A030096D	A020096DF	A030096DF	Anteriore DX	500	56	
A010096S	A020096S	A030096S	A020096SF	A030096SF	Anteriore SX	500	56	
A010097D	A020097D	A030097D	A020097DF	A030097DF	Anteriore DX	500	100	
A010097S	A020097S	A030097S	A020097SF	A030097SF	Anteriore SX	500	100	
A010098	A020098	A030098	A020098F	A030098F	Centrale	500	100	
A010099D	A020099D	A030099D	A020099DF	A030099DF	Posteriore DX	500	100	
A010099S	A020099S	A030099S	A020099SF	A030099SF	Posteriore SX	500	100	
A010083D	A020083D	A030083D	A020083DF	A030083DF	Posteriore DX	500/625	100	
A010083S	A020083S	A030083S	A020083SF	A030083SF	Posteriore SX	500/625	100	



S.P. 231 (Ex S.S. 98) Km. 79+850 - 70026 MODUGNO (BA)  
<http://www.cmvisrl.com> - email: [info@cmvisrl.com](mailto:info@cmvisrl.com)  
 Tel.: 080 - 5358899 - Fax: 080 - 5358909  
 P.IVA: 05329520729

**MONTANTI**

**MONTANTE RIBALTABILE E FISSO ANTERIORE ALTO**  
**A SALDARE Spessore mm 33**

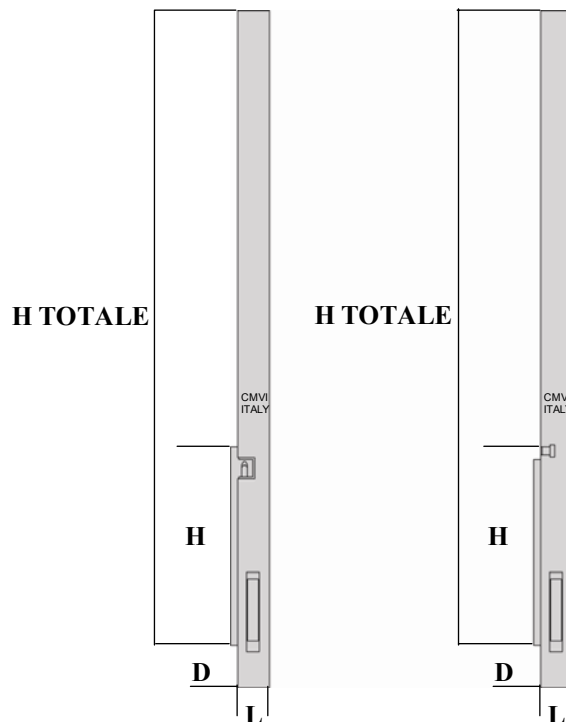

FERRO	INOX 304 PARZIALE	INOX 304 TOTALE	INOX 304 P. FIORET.	INOX 304 T. FIORET.					
CODICE	CODICE	CODICE	CODICE	CODICE	H. TOTALE	DESCRIZIONE	H.	L.	D
A010070D	A010970D	A011070D	A010970DF	A011070DF	1600	Ant. R. R. DX	300	85	140
A010070S	A010970S	A011070S	A010970SF	A011070SF	1600	Ant. R. R. SX	300	85	140
A010071D	A010971D	A011071D	A010971DF	A011071DF	1600	Ant. R. R. DX	350	85	140
A010071S	A010971S	A011071S	A010971SF	A011071SF	1600	Ant. R. R. SX	350	85	140
A010072D	A010972D	A011072D	A010972DF	A011072DF	1600	Ant. R. R. DX	400	85	140
A010072S	A010972S	A011072S	A010972SF	A011072SF	1600	Ant. R. R. SX	400	85	140
A010073D	A010973D	A011073D	A010973DF	A011073DF	1800	Ant. R. R. DX	500	85	140
A010073S	A010973S	A011073S	A010973SF	A011073SF	1800	Ant. R. R. SX	500	85	140
A010074D	A010974D	A011074D	A010974DF	A011074DF	1600	Ant. Sfil. DX	400	85	140
A010074S	A010974S	A011074S	A010974SF	A011074SF	1600	Ant. Sfil. SX	400	85	140
A010075D	A010975D	A011075D	A010975DF	A011075DF	1800	Ant. Sfil. DX	500	85	140
A010075S	A010975S	A011075S	A010975SF	A011075SF	1800	Ant. Sfil. SX	500	85	140
E039278D	E059278D	E049278D	E059278DF	E049278DF	1600	Ant. C.F. DX	400	85	140
E039278S	E059278S	E049278S	E059278SF	E049278SF	1600	Ant. C.F. SX	400	85	140
E039282D	E059282D	E049282D	E059282DF	E049282DF	1800	Ant. C.F. DX	500	85	140
E039282S	E059282S	E049282S	E059282SF	E049282SF	1800	Ant. C.F. SX	500	85	140



S.P. 231 (Ex S.S. 98) Km. 79+850 - 70026 MODUGNO (BA)  
<http://www.cmvisrl.com> - email: [info@cmvisrl.com](mailto:info@cmvisrl.com)  
 Tel.: 080 - 5358899 - Fax: 080 - 5358909  
 P.IVA: 05329520729

**MONTANTI**

MONTANTE RIBALTABILE E FISSO ANTERIORE ALTO  
 A SALDARE **Spessore mm 33**

H TOTALE

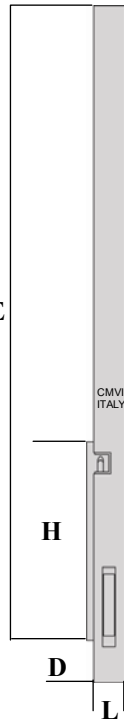

H TOTALE

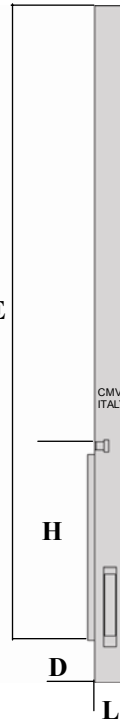

SERIE LEGGERA

FERRO	INOX 304 PARZIALE	INOX 304 TOTALE	INOX 304 P. FIORET.	INOX 304 T. FIORET.					
CODICE	CODICE	CODICE	CODICE	CODICE	H. TOTALE	DESCRIZIONE	H.	L.	D
E039285D	E059285D	E049285D	E059285DF	E049285DF	1600	Ant. R. R. DX	300	60	100
E039285S	E059285S	E049285S	E059285SF	E049285SF	1600	Ant. R. R. SX	300	60	100
E0389286D	E059286D	E049286D	E059286DF	E049286DF	1600	Ant. R. R. DX	350	60	100
E0389286S	E059286S	E049286S	E059286SF	E049286SF	1600	Ant. R. R. SX	350	60	100
E0739287D	E059287D	E049287D	E059287DF	E049287DF	1600	Ant. R. R. DX	400	60	100
E0739287S	E059287S	E049287S	E059287SF	E049287SF	1600	Ant. R. R. SX	400	60	100
E1089288D	E059288D	E049288D	E059288DF	E049288DF	1600	Ant. R. R. DX	500	60	100
E1089288S	E059288S	E049288S	E059288SF	E049288SF	1600	Ant. R. R. SX	500	60	100
E1439289D	E059289D	E049289D	E059289DF	E049289DF	1600	Ant. Sfil. DX	400	60	100
E1439289S	E059289S	E049289S	E059289SF	E049289SF	1600	Ant. Sfil. SX	400	60	100
E1789290D	E059290D	E049290D	E059290DF	E049290DF	1600	Ant. Sfil. DX	500	60	100
E1789290S	E059290S	E049290S	E059290SF	E049290SF	1600	Ant. Sfil. SX	500	60	100
E2139291D	E059291D	E049291D	E059291DF	E049291DF	1600	Ant. C.F. DX	400	60	100
E2139291S	E059291S	E049291S	E059291SF	E049291SF	1600	Ant. C.F. SX	400	60	100
E2489292D	E059292D	E049292D	E059292DF	E049292DF	1600	Ant. C.F. DX	500	60	100
E2489292S	E059292S	E049292S	E059292SF	E049292SF	1600	Ant. C.F. SX	500	60	100



S.P. 231 (Ex S.S. 98) Km. 79+850 - 70026 MODUGNO (BA)  
<http://www.cmvisrl.com> - email: [info@cmvisrl.com](mailto:info@cmvisrl.com)  
 Tel.: 080 - 5358899 - Fax: 080 - 5358909  
 P.IVA: 05329520729

MONTANTI

MONTANTE ROVESCIBILE RIBALTABILE  
 SGANCIABILE **SPESSORE mm 33**

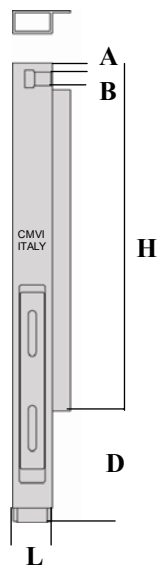

Caratteristiche Tecniche

A	B	D			
12	32	140			

FERRO	INOX 304 PARZIALE	INOX 304 TOTALE	INOX 304 P. FIORET.	INOX 304 T. FIORET.				
CODICE	CODICE	CODICE	CODICE	CODICE	DESCRIZIONE	H.	L.	
A040150D	A050150D	A060150D	A050150DF	A060150DF	Anteriore DX	400	56	
A040150S	A050150S	A060150S	A050150SF	A060150SF	Anteriore SX	400	56	
A040151D	A050151D	A060151D	A050151DF	A060151DF	Anteriore DX	500	56	
A040151S	A050151S	A060151S	A050151SF	A060151SF	Anteriore SX	500	56	
A040152D	A050152D	A060152D	A050152DF	A060152DF	Anteriore DX	600	56	
A040152S	A050152S	A060152S	A050152SF	A060152SF	Anteriore SX	600	56	
A040153D	A050153D	A060153D	A050153DF	A060153DF	Anteriore DX	700	56	
A040153S	A050153S	A060153S	A050153SF	A060153SF	Anteriore SX	700	56	
A040154D	A050154D	A060154D	A050154DF	A060154DF	Anteriore DX	800	56	
A040154S	A050154S	A060154S	A050154SF	A060154SF	Anteriore SX	800	56	
A040155D	A050155D	A060155D	A050155DF	A060155DF	Anteriore DX	900	56	
A040155S	A050155S	A060155S	A050155SF	A060155SF	Anteriore SX	900	56	
A040156D	A050156D	A060156D	A050156DF	A060156DF	Anteriore DX	1000	56	
A040156S	A050156S	A060156S	A050156SF	A060156SF	Anteriore SX	1000	56	
A040157D	A050157D	A060157D	A050157DF	A060157DF	Anteriore DX	1100	56	
A040157S	A050157S	A060157S	A050157SF	A060157SF	Anteriore SX	1100	56	
A040158D	A050158D	A060158D	A050158DF	A060158DF	Anteriore DX	1200	56	
A040158S	A050158S	A060158S	A050158SF	A060158SF	Anteriore SX	1200	56	



S.P. 231 (Ex S.S. 98) Km. 79+850 - 70026 MODUGNO (BA)  
<http://www.cmvisrl.com> - email: [info@cmvisrl.com](mailto:info@cmvisrl.com)  
 Tel.: 080 - 5358899 - Fax: 080 - 5358909  
 P.IVA: 05329520729

**MONTANTI**

**MONTANTE ROVESCIBILE RIBALTABILE**

**Spessore mm 33**

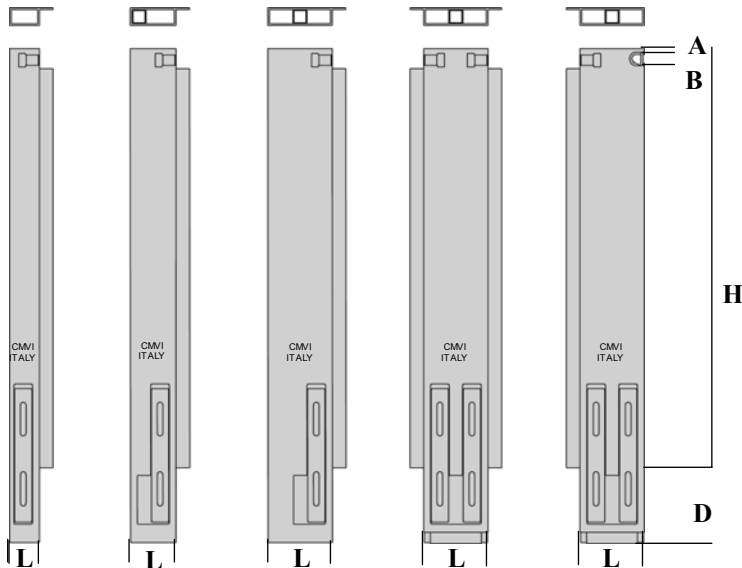

**Caratteristiche Tecniche**

H.	A	B	D		
400	12	32	140		
500	12	32	140		

FERRO	INOX 304 PARZIALE	INOX 304 TOTALE	INOX 304 P. FIORET.	INOX 304 T. FIORET.				
CODICE	CODICE	CODICE	CODICE	CODICE	DESCRIZIONE	H.	L.	PESO gr
A040100D	A050100D	A051100D	A050100DF	A051100DF	Anteriore DX	400	56	
A040100S	A050100S	A051100S	A050100SF	A051100SF	Anteriore SX	400	56	
A010100D	A020100D	A030100D	A020100DF	A030100DF	Anteriore DX	400	85	
A010100S	A020100S	A030100S	A020100SF	A030100SF	Anteriore SX	400	85	
A010101D	A020101D	A030101D	A020101DF	A030101DF	Anteriore DX	400	120	
A010101S	A020101S	A030101S	A020101SF	A030101SF	Anteriore SX	400	120	
A010102	A020102	A030102	A020102F	A030102F	Centrale	400	120	
A010103D	A020103D	A030103D	A020103DF	A030103DF	Posteriore DX	400	120	
A010103S	A020103S	A030103S	A020103SF	A030103SF	Posteriore SX	400	120	

A040104D	A050104D	A051104D	A050104DF	A051104DF	Anteriore DX	500	56	
A040104S	A050104S	A051104S	A050104SF	A051104SF	Anteriore SX	500	56	
A010104D	A020104D	A030104D	A020104DF	A030104DF	Anteriore DX	500	85	
A010104S	A020104S	A030104S	A020104SF	A030104SF	Anteriore SX	500	85	
A010105D	A020105D	A030105D	A020105DF	A030105DF	Anteriore DX	500	120	
A010105S	A020105S	A030105S	A020105SF	A030105SF	Anteriore SX	500	120	
A010106	A020106	A030106	A020106F	A030106F	Centrale	500	120	
A010107D	A020107D	A030107D	A020107DF	A030107DF	Posteriore DX	500	120	
A010107S	A020107S	A030107S	A020107SF	A030107SF	Posteriore SX	500	120	





S.P. 231 (Ex S.S. 98) Km. 79+850 - 70026 MODUGNO (BA)  
<http://www.cmvisrl.com> - email: [info@cmvisrl.com](mailto:info@cmvisrl.com)  
 Tel.: 080 - 5358899 - Fax: 080 - 5358909  
 P.IVA: 05329520729

**MONTANTI**

MONTANTE ROVESCIBILE RIBALTABILE

**Spessore mm 33**

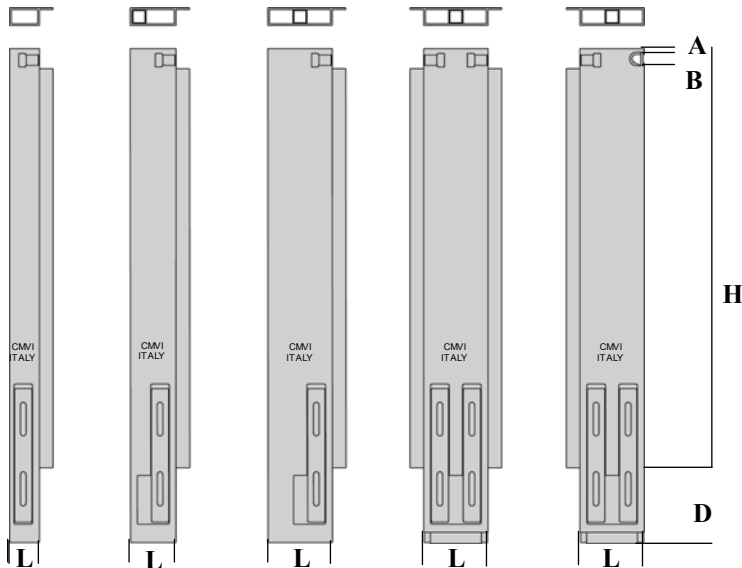

**Caratteristiche Tecniche**

H.	A	B	D		
600	12	32	140		
700	12	32	140		

FERRO	INOX 304 PARZIALE	INOX 304 TOTALE	INOX 304 P. FIORET.	INOX 304 T. FIORET.				
CODICE	CODICE	CODICE	CODICE	CODICE	DESCRIZIONE	H.	L.	PESO gr
A040108D	A050108D	A051108D	A050108DF	A051108DF	Anteriore DX	600	56	
A040108S	A050108S	A051108S	A050108SF	A051108SF	Anteriore SX	600	56	
A010108D	A020108D	A030108D	A020108DF	A030108DF	Anteriore DX	600	85	
A010108S	A020108S	A030108S	A020108SF	A030108SF	Anteriore SX	600	85	
A010109D	A020109D	A030109D	A020109DF	A030109DF	Anteriore DX	600	120	
A010109S	A020109S	A030109S	A020109SF	A030109SF	Anteriore SX	600	120	
A010110	A020110	A030110	A020110F	A030110F	Centrale	600	120	
A010111D	A020111D	A030111D	A020111DF	A030111DF	Posteriore DX	600	120	
A010111S	A020111S	A030111S	A020111SF	A030111SF	Posteriore SX	600	120	

A040112D	A050112D	A051112D	A050112DF	A051112DF	Anteriore DX	700	56	
A040112S	A050112S	A051112S	A050112SF	A051112SF	Anteriore SX	700	56	
A010112D	A020112D	A030112D	A020112DF	A030112DF	Anteriore DX	700	85	
A010112S	A020112S	A030112S	A020112SF	A030112SF	Anteriore SX	700	85	
A010113D	A020113D	A030113D	A020113DF	A030113DF	Anteriore DX	700	120	
A010113S	A020113S	A030113S	A020113SF	A030113SF	Anteriore SX	700	120	
A010114	A020114	A030114	A020114F	A030114F	Centrale	700	120	
A010115D	A020115D	A030115D	A020115DF	A030115DF	Posteriore DX	700	120	
A010115S	A020115S	A030115S	A020115SF	A030115SF	Posteriore SX	700	120	



S.P. 231 (Ex S.S. 98) Km. 79+850 - 70026 MODUGNO (BA)  
<http://www.cmvisrl.com> - email: [info@cmvisrl.com](mailto:info@cmvisrl.com)  
 Tel.: 080 - 5358899 - Fax: 080 - 5358909  
 P.IVA: 05329520729

**MONTANTI**

MONTANTE ROVESCIBILE RIBALTABILE

**Spessore mm 33**

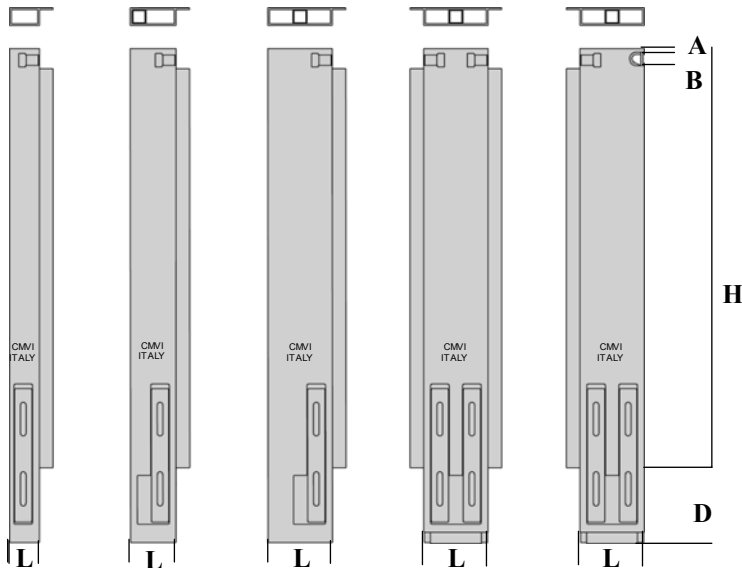

**Caratteristiche Tecniche**

H.	A	B	D		
800	12	32	140		
900	12	32	140		

FERRO	INOX 304 PARZIALE	INOX 304 TOTALE	INOX 304 P. FIORET.	INOX 304 T. FIORET.				
CODICE	CODICE	CODICE	CODICE	CODICE	DESCRIZIONE	H.	L.	PESO gr
A040116D	A050116D	A051116D	A050116DF	A051116DF	Anteriore DX	800	56	
A040116S	A050116S	A051116S	A050116SF	A051116SF	Anteriore SX	800	56	
A010116D	A020116D	A030116D	A020116DF	A030116DF	Anteriore DX	800	85	
A010116S	A020116S	A030116S	A020116SF	A030116SF	Anteriore SX	800	85	
A010117D	A020117D	A030117D	A020117DF	A030117DF	Anteriore DX	800	120	
A010117S	A020117S	A030117S	A020117SF	A030117SF	Anteriore SX	800	120	
A010118	A020118	A030118	A020118F	A030118F	Centrale	800	120	
A010119D	A020119D	A030119D	A020119DF	A030119DF	Posteriore DX	800	120	
A010119S	A020119S	A030119S	A020119SF	A030119SF	Posteriore SX	800	120	

A040120D	A050120D	A051120D	A050120DF	A051120DF	Anteriore DX	900	56	
A040120S	A050120S	A051120S	A050120SF	A051120SF	Anteriore SX	900	56	
A010120D	A020120D	A030120D	A020120DF	A030120DF	Anteriore DX	900	85	
A010120S	A020120S	A030120S	A020120SF	A030120SF	Anteriore SX	900	85	
A010121D	A020121D	A030121D	A020121DF	A030121DF	Anteriore DX	900	120	
A010121S	A020121S	A030121S	A020121SF	A030121SF	Anteriore SX	900	120	
A010122	A020122	A030122	A020122F	A030122F	Centrale	900	120	
A010123D	A020123D	A030123D	A020123DF	A030123DF	Posteriore DX	900	120	
A010123S	A020123S	A030123S	A020123SF	A030123SF	Posteriore SX	900	120	



S.P. 231 (Ex S.S. 98) Km. 79+850 - 70026 MODUGNO (BA)  
<http://www.cmvisrl.com> - email: [info@cmvisrl.com](mailto:info@cmvisrl.com)  
 Tel.: 080 - 5358899 - Fax: 080 - 5358909  
 P.IVA: 05329520729

MONTANTI

MONTANTE ROVESCIBILE RIBALTABILE  
**SPESSORE mm 33**

2 LEVE - 1 CHIUSURA

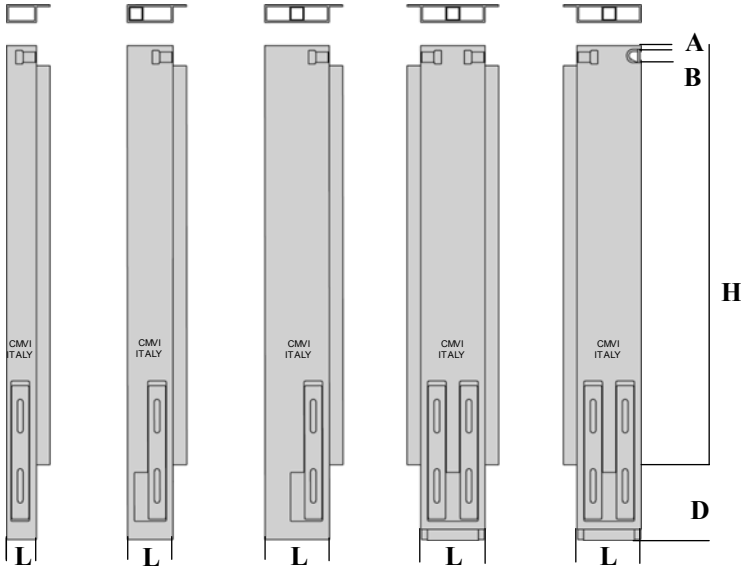

Caratteristiche Tecniche

H.	A	B	D		
1000	12	32	140		
1100	12	32	140		

FERRO	INOX 304 PARZIALE	INOX 304 TOTALE	INOX 304 P. FIORET.	INOX 304 T. FIORET.				
CODICE	CODICE	CODICE	CODICE	CODICE	DESCRIZIONE	H.	L.	PESO gr
A050124D	A055124D	A056124D	A055124DF	A056124DF	Anteriore DX	1000	56	
A050124S	A055124S	A056124S	A055124SF	A056124SF	Anteriore SX	1000	56	
A040124D	A045124D	A046124D	A045124DF	A046124DF	Anteriore DX	1000	85	
A040124S	A045124S	A046124S	A045124SF	A046124SF	Anteriore SX	1000	85	
A040125D	A045125D	A046125D	A045125DF	A046125DF	Anteriore DX	1000	120	
A040125S	A045125S	A046125S	A045125SF	A046125SF	Anteriore SX	1000	120	
A040126	A045126	A046126	A020122F	A030122F	Centrale	1000	120	
A040127D	A045127D	A046127D	A045127DF	A046127DF	Posteriore DX	1000	120	
A040127S	A045127S	A046127S	A045127SF	A046127SF	Posteriore SX	1000	120	

A050128D	A055128D	A056128D	A055128DF	A056128DF	Anteriore DX	1100	56	
A050128S	A055128S	A056128S	A055128SF	A056128SF	Anteriore SX	1100	56	
A040128D	A045128D	A046128D	A045128DF	A046128DF	Anteriore DX	1100	85	
A040128S	A045128S	A046128S	A045128SF	A046128SF	Anteriore SX	1100	85	
A040129D	A045129D	A046129D	A045129DF	A046129DF	Anteriore DX	1100	120	
A040129S	A045129S	A046129S	A045129SF	A046129SF	Anteriore SX	1100	120	
A040130	A045130	A046130	A045130F	A046130F	Centrale	1100	120	
A040131D	A045131D	A046131D	A045131DF	A046131DF	Posteriore DX	1100	120	
A040131S	A045131S	A046131S	A045131SF	A046131SF	Posteriore SX	1100	120	



S.P. 231 (Ex S.S. 98) Km. 79+850 - 70026 MODUGNO (BA)  
<http://www.cmvisrl.com> - email: [info@cmvisrl.com](mailto:info@cmvisrl.com)  
 Tel.: 080 - 5358899 - Fax: 080 - 5358909  
 P.IVA: 05329520729

**MONTANTI**

**MONTANTE ROVESCIBILE RIBALTABILE  
 SPESSORE mm 33**

2 LEVE - 1 CHIUSURA

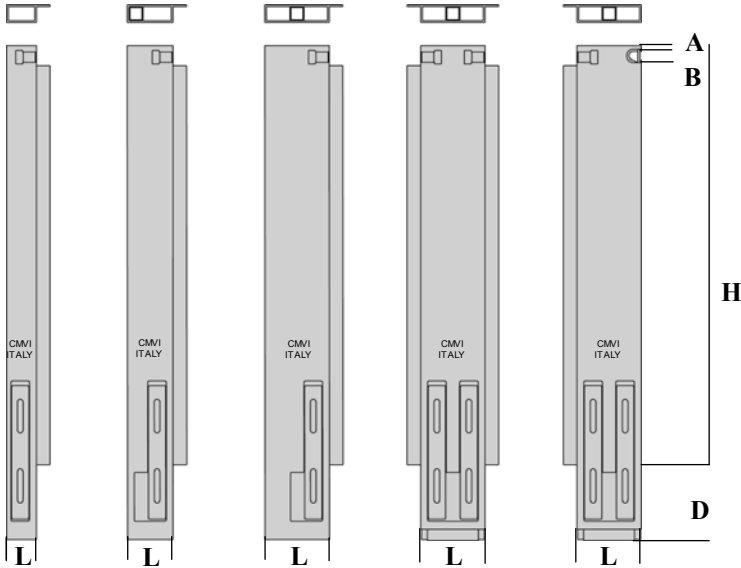

**Caratteristiche Tecniche**

H.	A	B	D					
1200	13	30	140					
FERRO	INOX 304 PARZIALE	INOX 304 TOTALE	INOX 304 P. FIORET.	INOX 304 T. FIORET.	DESCRIZIONE	H.	L.	PESO gr
CODICE	CODICE	CODICE	CODICE	CODICE				
A050132D	A055132D	A056132D	A055132DF	A056132DF	Anteriore DX	1200	56	
A050132S	A055132S	A056132S	A055132SF	A056132SF	Anteriore SX	1200	56	
A040132D	A045132D	A046132D	A045132DF	A046132DF	Anteriore DX	1200	85	
A040132S	A045132S	A046132S	A045132SF	A046132SF	Anteriore SX	1200	85	
A040133D	A045133D	A046133D	A045133DF	A046133DF	Anteriore DX	1200	120	
A040133S	A045133S	A046133S	A045133SF	A046133SF	Anteriore SX	1200	120	
A040134	A045134	A046134	A045134F	A046134F	Centrale	1200	120	
A040135D	A045135D	A046135D	A045135DF	A046135DF	Posteriore DX	1200	120	
A040135S	A045135S	A046135S	A045135SF	A046135SF	Posteriore SX	1200	120	



S.P. 231 (Ex S.S. 98) Km. 79+850 - 70026 MODUGNO (BA)  
 http://www.cmvisrl.com - email: info@cmvisrl.com  
 Tel.: 080 - 5358899 - Fax: 080 - 5358909  
 P.IVA: 05329520729

**MONTANTI**

**MONTANTE ROVESCIBILE RIBALTABILE**  
**SPESSORE mm 33**

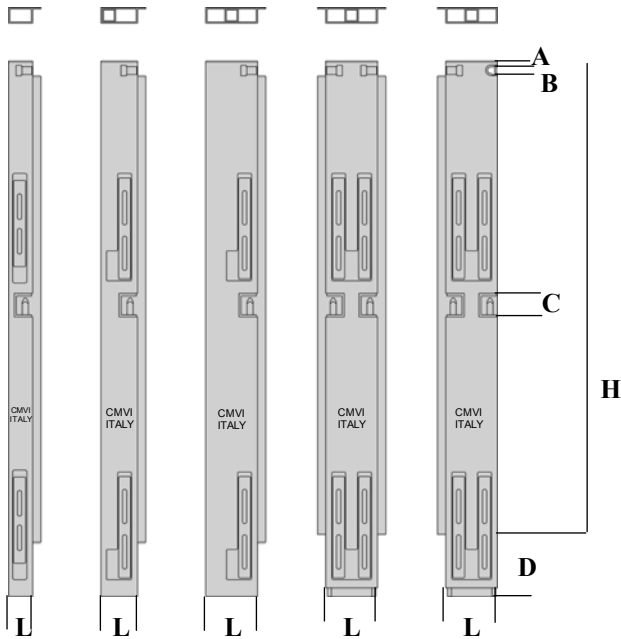

**4 LEVE - 2 CHIUSURE**

**Caratteristiche Tecniche**

H.	A	B	C	D	
900	12	30	55	140	
1000	12	30	55	140	

FERRO	INOX 304 PARZIALE	INOX 304 TOTALE	INOX 304 P. FIORET.	INOX 304 T. FIORET.				
CODICE	CODICE	CODICE	CODICE	CODICE	DESCRIZIONE	H.	L.	PESO gr
A014120D	A015120D	A016120D	A015120DF	A016120DF	Anteriore DX	900	56	
A014120S	A015120S	A016120S	A015120SF	A016120SF	Anteriore SX	900	56	
A011120D	A012120D	A013120D	A012120DF	A013120DF	Anteriore DX	900	85	
A011120S	A012120S	A013120S	A012120SF	A013120SF	Anteriore SX	900	85	
A011121D	A012121D	A013121D	A012121DF	A013121DF	Anteriore DX	900	120	
A011121S	A012121S	A013121S	A012121SF	A013121SF	Anteriore SX	900	120	
A011122	A012122	A013122	A020122F	A030122F	Centrale	900	120	
A011123D	A012123D	A013123D	A012123DF	A013123DF	Posteriore DX	900	120	
A011123S	A012123S	A013123S	A012123SF	A013123SF	Posteriore SX	900	120	

A060124D	A065124D	A066124D	A065124DF	A066124DF	Anteriore DX	1000	56	
A060124S	A065124S	A066124S	A065124SF	A066124SF	Anteriore SX	1000	56	
A010124D	A020124D	A030124D	A020124DF	A030124DF	Anteriore DX	1000	85	
A010124S	A020124S	A030124S	A020124SF	A030124SF	Anteriore SX	1000	85	
A010125D	A020125D	A030125D	A020125DF	A030125DF	Anteriore DX	1000	120	
A010125S	A020125S	A030125S	A020125SF	A030125SF	Anteriore SX	1000	120	
A010126	A020126	A030126	A020126F	A030126F	Centrale	1000	120	
A010127D	A020127D	A030127D	A020127DF	A030127DF	Posteriore DX	1000	120	
A010127S	A020127S	A030127S	A020127SF	A030127SF	Posteriore SX	1000	120	



S.P. 231 (Ex S.S. 98) Km. 79+850 - 70026 MODUGNO (BA)  
 http://www.cmvisrl.com - email: info@cmvisrl.com  
 Tel.: 080 - 5358899 - Fax: 080 - 5358909  
 P.IVA: 05329520729

**MONTANTI**

**MONTANTE ROVESCIBILE RIBALTABILE  
 SPESSORE mm 33**

**4 LEVE - 2 CHIUSURE**

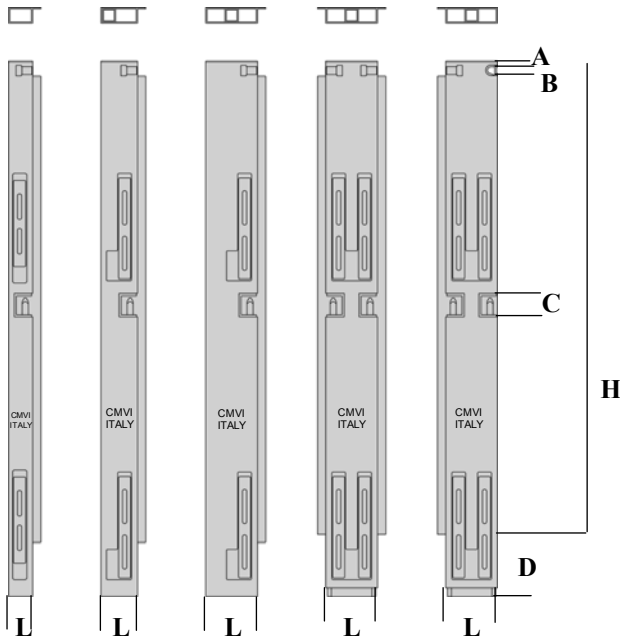

**Caratteristiche Tecniche**

H.	A	B	C	D	
1100	13	30	55	140	
1200	13	30	55	140	

FERRO	INOX 304 PARZIALE	INOX 304 TOTALE	INOX 304 P. FIORET.	INOX 304 T. FIORET.	DESCRIZIONE	H.	L.	PESO gr
A060128D	A065128D	A066128D	A065128DF	A066128DF	Anteriore DX	1100	56	
A060128S	A065128S	A066128S	A065128SF	A066128SF	Anteriore SX	1100	56	
A010128D	A020128D	A030128D	A020128DF	A030128DF	Anteriore DX	1100	85	
A010128S	A020128S	A030128S	A020128SF	A030128SF	Anteriore SX	1100	85	
A010129D	A020129D	A030129D	A020129DF	A030129DF	Anteriore DX	1100	120	
A010129S	A020129S	A030129S	A020129SF	A030129SF	Anteriore SX	1100	120	
A010130	A020130	A030130	A020130F	A030130F	Centrale	1100	120	
A010131D	A020131D	A030131D	A020131DF	A030131DF	Posteriore DX	1100	120	
A010131S	A020131S	A030131S	A020131SF	A030131SF	Posteriore SX	1100	120	

A060132D	A065132D	A066132D	A065132DF	A066132DF	Anteriore DX	1200	56	
A060132S	A065132S	A066132S	A065132SF	A066132SF	Anteriore SX	1200	56	
A010132D	A020132D	A030132D	A020132DF	A030132DF	Anteriore DX	1200	85	
A010132S	A020132S	A030132S	A020132SF	A030132SF	Anteriore SX	1200	85	
A010133D	A020133D	A030133D	A020133DF	A030133DF	Anteriore DX	1200	120	
A010133S	A020133S	A030133S	A020133SF	A030133SF	Anteriore SX	1200	120	
A010134	A020134	A030134	A020134F	A030134F	Centrale	1200	120	
A010135D	A020135D	A030135D	A020135DF	A030135DF	Posteriore DX	1200	120	
A010135S	A020135S	A030135S	A020135SF	A030135SF	Posteriore SX	1200	120	



S.P. 231 (Ex S.S. 98) Km. 79+850 - 70026 MODUGNO (BA)  
 http://www.cmvisrl.com - email: info@cmvisrl.com  
 Tel.: 080 - 5358899 - Fax: 080 - 5358909  
 P.IVA: 05329520729

**MONTANTI**

**MONTANTE ANTERIORE LARGO SFILABILE CON  
 INNESTO SPESSORE mm 33**

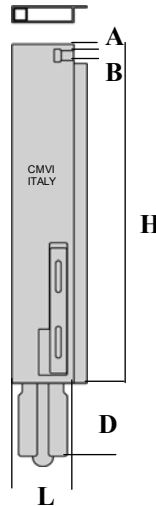

**Caratteristiche Tecniche**

A	B	D			
12	32	140			

FERRO	INOX 304 PARZIALE	INOX 304* TOTALE	INOX 304 P. FIORET.	INOX 304 T. FIORET.				
CODICE	CODICE	CODICE	CODICE	CODICE	DESCRIZIONE	H.	L.	
C010188D	C020188D	C030188D	C020188DF	C030188DF	Anteriore DX	400	120	
C010188S	C020188S	C030188S	C020188SF	C030188SF	Anteriore SX	400	120	
C010189D	C020189D	C030189D	C020189DF	C030189DF	Anteriore DX	500	120	
C010189S	C020189S	C030189S	C020189SF	C030189SF	Anteriore SX	500	120	
C010190D	C020190D	C030190D	C020190DF	C030190DF	Anteriore DX	600	120	
C010190S	C020190S	C030190S	C020190SF	C030190SF	Anteriore SX	600	120	
C010191D	C020191D	C030191D	C020191DF	C030191DF	Anteriore DX	700	120	
C010191S	C020191S	C030191S	C020191SF	C030191SF	Anteriore SX	700	120	
C010192D	C020192D	C030192D	C020192DF	C030192DF	Anteriore DX	800	120	
C010192S	C020192S	C030192S	C020192SF	C030192SF	Anteriore SX	800	120	
C010193D	C020193D	C030193D	C020193DF	C030193DF	Anteriore DX	900	120	
C010193S	C020193S	C030193S	C020193SF	C030193SF	Anteriore SX	900	120	
C010194D	C020194D	C030194D	C020194DF	C030194DF	Anteriore DX	1000	120	
C010194S	C020194S	C030194S	C020194SF	C030194SF	Anteriore SX	1000	120	
C010195D	C020195D	C030195D	C020195DF	C030195DF	Anteriore DX	1100	120	
C010195S	C020195S	C030195S	C020195SF	C030195SF	Anteriore SX	1100	120	
C010196D	C020196D	C030196D	C020196DF	C030196DF	Anteriore DX	1200	120	
C010196S	C020196S	C030196S	C020196SF	C030196SF	Anteriore SX	1200	120	

\* N.B. Il montante ad innesto totalmente inox è fornito con la sede e l'innesto in FERRO.  
 Per la sede e l'innesto inox chiedere la differenza al momento dell'ordine



S.P. 231 (Ex S.S. 98) Km. 79+850 - 70026 MODUGNO (BA)  
<http://www.cmvisrl.com> - email: [info@cmvisrl.com](mailto:info@cmvisrl.com)  
 Tel.: 080 - 5358899 - Fax: 080 - 5358909  
 P.IVA: 05329520729

**MONTANTI**

**MONTANTE SFILABILE RIBALTABILE  
 SPESSORE mm 33**

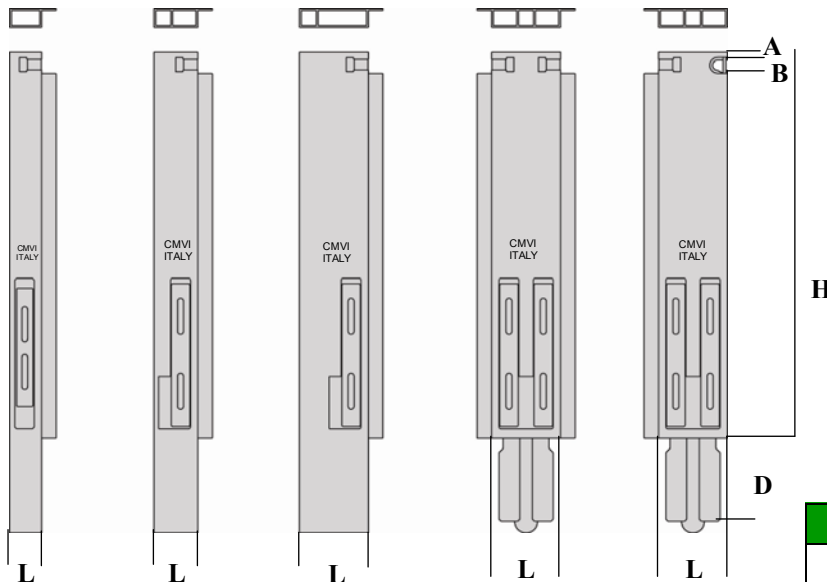

**Caratteristiche Tecniche**

H.	A	B	D		
400	12	32	140		
500	12	32	140		

FERRO	INOX 304 PARZIALE	INOX 304* TOTALE	INOX 304 P. FIORET.	INOX 304 T. FIORET.	DESCRIZIONE	H.	L.	PESO gr
C018156D	C017156D	C028156D	C017156DF	C028156DF	Anteriore DX	400	56	
C018156S	C017156S	C028156S	C017156SF	C028156SF	Anteriore SX	400	56	
C008156D	C019156D	C029156D	C019156DF	C029156DF	Anteriore DX	400	85	
C008156S	C019156S	C029156S	C019156SF	C029156SF	Anteriore SX	400	85	
C008157D	C019157D	C029157D	C019157DF	C029157DF	Anteriore DX	400	120	
C008157S	C019157S	C029157S	C019157SF	C029157SF	Anteriore SX	400	120	
C008158	C019158	C029158	C019158F	C029158F	Centrale	400	120	
C008159D	C019159D	C029159D	C019159DF	C029159DF	Posteriore DX	400	120	
C008159S	C019159S	C029159S	C019159SF	C029159SF	Posteriore SX	400	120	

C009156D	C021156D	C031156D	C021156DF	C031156DF	Anteriore DX	500	56	
C009156S	C021156S	C031156S	C021156SF	C031156SF	Anteriore SX	500	56	
C010156D	C020156D	C030156D	C020156DF	C030156DF	Anteriore DX	500	85	
C010156S	C020156S	C030156S	C020156SF	C030156SF	Anteriore SX	500	85	
C010157D	C020157D	C030157D	C020157DF	C030157DF	Anteriore DX	500	120	
C010157S	C020157S	C030157S	C020157SF	C030157SF	Anteriore SX	500	120	
C010158	C020158	C030158	C020158F	C030158F	Centrale	500	120	
C010159D	C020159D	C030159D	C020159DF	C030159DF	Posteriore DX	500	120	
C010159S	C020159S	C030159S	C020159SF	C030159SF	Posteriore SX	500	120	

\* N.B. Il montante ad innesto totalmente inox è fornito con la sede e l'innesto in FERRO.  
 Per la sede e l'innesto inox chiedere la differenza al momento dell'ordine





S.P. 231 (Ex S.S. 98) Km. 79+850 - 70026 MODUGNO (BA)  
 http://www.cmvisrl.com - email: info@cmvisrl.com  
 Tel.: 080 - 5358899 - Fax: 080 - 5358909  
 P.IVA: 05329520729

**MONTANTI**

**MONTANTE SFILABILE RIBALTABILE  
 SPESSORE mm 33**

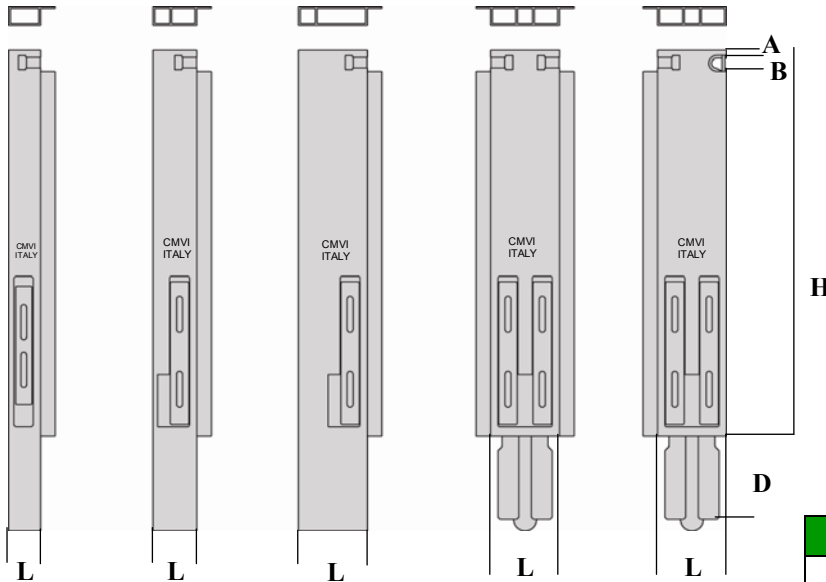

**Caratteristiche Tecniche**

H.	A	B	D		
600	12	32	140		
700	12	32	140		

FERRO	INOX 304 PARZIALE	INOX 304* TOTALE	INOX 304 P. FIORET.	INOX 304 T. FIORET.				
CODICE	CODICE	CODICE	CODICE	CODICE	DESCRIZIONE	H.	L.	PESO gr
C009160D	C021160D	C031160D	C021160DF	C031160DF	Anteriore DX	600	56	
C009160S	C021160S	C031160S	C021160SF	C031160SF	Anteriore SX	600	56	
C010160D	C020160D	C030160D	C020160DF	C030160DF	Anteriore DX	600	85	
C010160S	C020160S	C030160S	C020160SF	C030160SF	Anteriore SX	600	85	
C010161D	C020161D	C030161D	C020161DF	C030161DF	Anteriore DX	600	120	
C010161S	C020161S	C030161S	C020161SF	C030161SF	Anteriore SX	600	120	
C010162	C020162	C030162	C020162F	C030162F	Centrale	600	120	
C010163D	C020163D	C030163D	C020163DF	C030163DF	Posteriore DX	600	120	
C010163S	C020163S	C030163S	C020163SF	C030163SF	Posteriore SX	600	120	

C009164D	C021164D	C031164D	C021164DF	C031164DF	Anteriore DX	700	56	
C009164S	C021164S	C031164S	C021164SF	C031164SF	Anteriore SX	700	56	
C010164D	C020164D	C030164D	C020164DF	C030164DF	Anteriore DX	700	85	
C010164S	C020164S	C030164S	C020164SF	C030164SF	Anteriore SX	700	85	
C010165D	C020165D	C030165D	C020165DF	C030165DF	Anteriore DX	700	120	
C010165S	C020165S	C030165S	C020165SF	C030165SF	Anteriore SX	700	120	
C010166	C020166	C030166	C020166F	C030166F	Centrale	700	120	
C010167D	C020167D	C030167D	C020167DF	C030167DF	Posteriore DX	700	120	
C010167S	C020167S	C030167S	C020167SF	C030167SF	Posteriore SX	700	120	

\* N.B. Il montante ad innesto totalmente inox è fornito con la sede e l'innesto in FERRO.  
 Per la sede e l'innesto inox chiedere la differenza al momento dell'ordine



S.P. 231 (Ex S.S. 98) Km. 79+850 - 70026 MODUGNO (BA)  
 http://www.cmvisrl.com - email: info@cmvisrl.com  
 Tel.: 080 - 5358899 - Fax: 080 - 5358909  
 P.IVA: 05329520729

**MONTANTI**

**MONTANTE SFILABILE RIBALTABILE  
 SPESSORE mm 33**

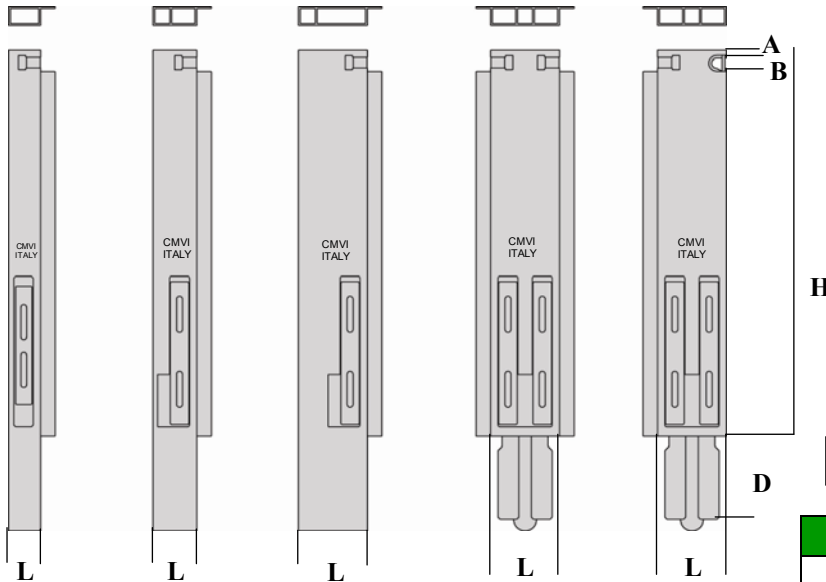

**Caratteristiche Tecniche**

H.	A	B	D		
800	12	32	140		
900	12	32	140		

FERRO	INOX 304 PARZIALE	INOX 304* TOTALE	INOX 304 P. FIORET.	INOX 304 T. FIORET.	DESCRIZIONE	H.	L.	PESO gr
C009168D	C021168D	C031168D	C021168DF	C031168DF	Anteriore DX	800	56	
C009168S	C021168S	C031168S	C021168SF	C031168SF	Anteriore SX	800	56	
C010168D	C020168D	C030168D	C020168DF	C030168DF	Anteriore DX	800	85	
C010168S	C020168S	C030168S	C020168SF	C030168SF	Anteriore SX	800	85	
C010169D	C020169D	C030169D	C020169DF	C030169DF	Anteriore DX	800	120	
C010169S	C020169S	C030169S	C020169SF	C030169SF	Anteriore SX	800	120	
C010170	C020170	C030170	C020170F	C030170F	Centrale	800	120	
C010171D	C020171D	C030171D	C020171DF	C030171DF	Posteriore DX	800	120	
C010171S	C020171S	C030171S	C020171SF	C030171SF	Posteriore SX	800	120	

C009172D	C021173D	C031172D	C021173DF	C031172DF	Anteriore DX	900	56	
C009172S	C021173S	C031172S	C021173SF	C031172SF	Anteriore SX	900	56	
C010172D	C020172D	C030172D	C020172DF	C030172DF	Anteriore DX	900	85	
C010172S	C020172S	C030172S	C020172SF	C030172SF	Anteriore SX	900	85	
C010173D	C020173D	C030173D	C020173DF	C030173DF	Anteriore DX	900	120	
C010173S	C020173S	C030173S	C020173SF	C030173SF	Anteriore SX	900	120	
C010174	C020174	C030174	C020174F	C030174F	Centrale	900	120	
C010175D	C020175D	C030175D	C020175DF	C030175DF	Posteriore DX	900	120	
C010175S	C020175S	C030175S	C020175SF	C030175SF	Posteriore SX	900	120	

\* N.B. Il montante ad innesto totalmente inox è fornito con la sede e l'innesto in FERRO.  
 Per la sede e l'innesto inox chiedere la differenza al momento dell'ordine



S.P. 231 (Ex S.S. 98) Km. 79+850 - 70026 MODUGNO (BA)  
 http://www.cmvisrl.com - email: info@cmvisrl.com  
 Tel.: 080 - 5358899 - Fax: 080 - 5358909  
 P.IVA: 05329520729

**MONTANTI**

**MONTANTE SFILABILE RIBALTABILE  
 SPESSORE mm 33**

**2 LEVE 1 CHIUSURA**

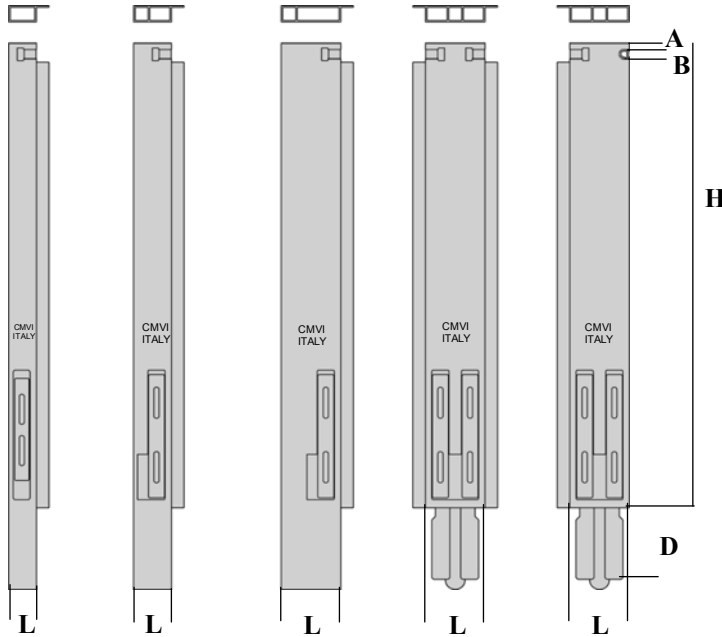

**Caratteristiche Tecniche**

H.	A	B	D		
1000	12	32	140		
1100	12	32	140		

FERRO	INOX 304 PARZIALE	INOX 304 TOTALE	INOX 304 P. FIORET.	INOX 304 T. FIORET.	DESCRIZIONE	H.	L.	PESO gr
C008176D	C018176D	C028176D	C018176DF	C028176DF	Anteriore DX	1000	56	
C008176S	C018176S	C028176S	C018176SF	C028176SF	Anteriore SX	1000	56	
C009176D	C019176D	C029176D	C019176DF	C029176DF	Anteriore DX	1000	85	
C009176S	C019176S	C029176S	C019176SF	C029176SF	Anteriore SX	1000	85	
C009177D	C019177D	C029177D	C019177DF	C029177DF	Anteriore DX	1000	120	
C009177S	C019177S	C029177S	C019177SF	C029177SF	Anteriore SX	1000	120	
C009178	C019178	C029178	C019178F	C029178F	Centrale	1000	120	
C009179D	C019179D	C029179D	C019179DF	C029179DF	Posteriore DX	1000	120	
C009179S	C019179S	C029179S	C019179SF	C029179SF	Posteriore SX	1000	120	

C008180D	C018180D	C028180D	C018180DF	C028180DF	Anteriore DX	1100	56	
C008180S	C018180S	C028180S	C018180SF	C028180SF	Anteriore SX	1100	56	
C009180D	C019180D	C029180D	C019180DF	C029180DF	Anteriore DX	1100	85	
C009180S	C019180S	C029180S	C019180SF	C029180SF	Anteriore SX	1100	85	
C009181D	C019181D	C029181D	C019181DF	C029181DF	Anteriore DX	1100	120	
C009181S	C019181S	C029181S	C019181SF	C029181SF	Anteriore SX	1100	120	
C009182	C019182	C029182	C019182F	C029182F	Centrale	1100	120	
C009183D	C019183D	C029183D	C019183DF	C029183DF	Posteriore DX	1100	120	
C009183S	C019183S	C029183S	C019183SF	C029183SF	Posteriore SX	1100	120	

\* N.B. Il montante ad innesto totalmente inox è fornito con la sede e l'innesto in FERRO.  
 Per la sede e l'innesto inox chiedere la differenza al momento dell'ordine

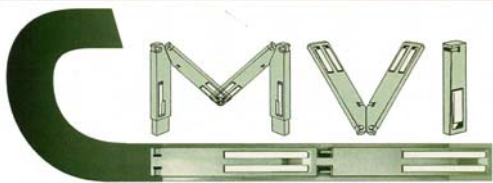

S.P. 231 (Ex S.S. 98) Km. 79+850 - 70026 MODUGNO (BA)  
 http://www.cmvisrl.com - email: info@cmvisrl.com  
 Tel.: 080 - 5358899 - Fax: 080 - 5358909  
 P.IVA: 05329520729

**MONTANTI**

**MONTANTE SFILABILE RIBALTABILE  
 SPESSORE mm 33**

**2 LEVE 1 CHIUSURA**

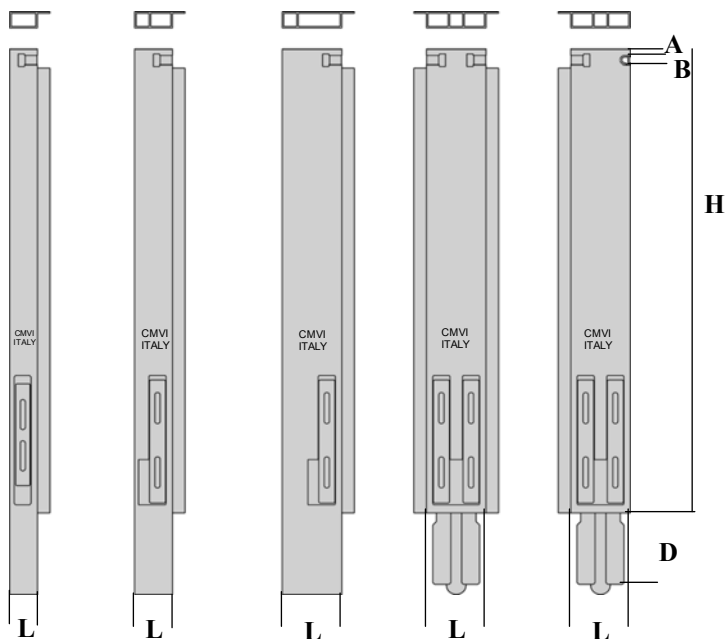

**Caratteristiche Tecniche**

H.	A	B	D					
1200	12	32	140					
FERRO	INOX 304 PARZIALE	INOX 304* TOTALE	INOX 304 P. FIORET.	INOX 304 T. FIORET.	DESCRIZIONE	H.	L.	PESO gr
C008184D	C018184D	C028184D	C018184DF	C028184DF	Anteriore DX	1200	56	
C008184S	C018184S	C028184S	C018184SF	C028184SF	Anteriore SX	1200	56	
C009184D	C019184D	C029184D	C019184DF	C029184DF	Anteriore DX	1200	85	
C009184S	C019184S	C029184S	C019184SF	C029184SF	Anteriore SX	1200	85	
C009185D	C019185D	C029185D	C019185DF	C029185DF	Anteriore DX	1200	120	
C009185S	C019185S	C029185S	C019185SF	C029185SF	Anteriore SX	1200	120	
C009186	C019186	C029186	C019186F	C029186F	Centrale	1200	120	
C009187D	C019187D	C029187D	C019187DF	C029187DF	Posteriore DX	1200	120	
C009187S	C019187S	C029187S	C019187SF	C029187SF	Posteriore SX	1200	120	

\* N.B. Il montante ad innesto totalmente inox è fornito con la sede e l'innesto in FERRO.  
 Per la sede e l'innesto inox chiedere la differenza al momento dell'ordine



S.P. 231 (Ex S.S. 98) Km. 79+850 - 70026 MODUGNO (BA)  
 http://www.cmvisrl.com - email: info@cmvisrl.com  
 Tel.: 080 - 5358899 - Fax: 080 - 5358909  
 P.IVA: 05329520729

**MONTANTI**

**MONTANTE SFILABILE RIBALTABILE  
 SPESSORE mm 33**

**4 LEVE - 2 CHIUSURE**

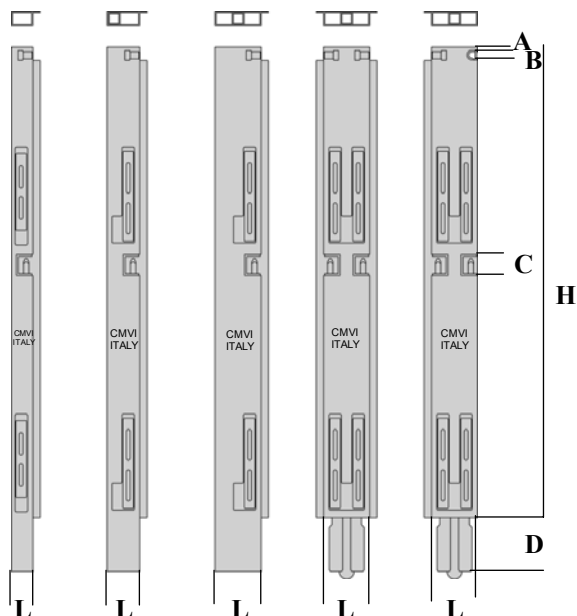

**Caratteristiche Tecniche**

H.	A	B	C	D	
900	12	32	55	140	
1000	12	32	55	140	

FERRO	INOX 304 PARZIALE	INOX 304* TOTALE	INOX 304 P. FIORET.	INOX 304 T. FIORET.	DESCRIZIONE	H.	L.	PESO gr
C011172D	C021172D	C031173D	C021172DF	C031173DF	Anteriore DX	900	56	
C011172S	C021172S	C031173S	C021172SF	C031173SF	Anteriore SX	900	56	
C012172D	C022172D	C032172D	C022172DF	C032172DF	Anteriore DX	900	85	
C012172S	C022172S	C032172S	C022172SF	C032172SF	Anteriore SX	900	85	
C012173D	C022173D	C032173D	C022173DF	C032173DF	Anteriore DX	900	120	
C012173S	C022173S	C032173S	C022173SF	C032173SF	Anteriore SX	900	120	
C012174	C022174	C032174	C022174F	C032174F	Centrale	900	120	
C012175D	C022175D	C032175D	C022175DF	C032175DF	Posteriore DX	900	120	
C012175S	C022175S	C032175S	C022175SF	C032175SF	Posteriore SX	900	120	

C011176D	C021176D	C031176D	C021176DF	C031176DF	Anteriore DX	1000	56	
C011176S	C021176S	C031176S	C021176SF	C031176SF	Anteriore SX	1000	56	
C010176D	C020176D	C030176D	C020176DF	C030176DF	Anteriore DX	1000	85	
C010176S	C020176S	C030176S	C020176SF	C030176SF	Anteriore SX	1000	85	
C010177D	C020177D	C030177D	C020177DF	C030177DF	Anteriore DX	1000	120	
C010177S	C020177S	C030177S	C020177SF	C030177SF	Anteriore SX	1000	120	
C010178	C020178	C030178	C020178F	C030178F	Centrale	1000	120	
C010179D	C020179D	C030179D	C020179DF	C030179DF	Posteriore DX	1000	120	
C010179S	C020179S	C030179S	C020179SF	C030179SF	Posteriore SX	1000	120	

\* N.B. Il montante ad innesto totalmente inox è fornito con la sede e l'innesto in FERRO.  
 Per la sede e l'innesto inox chiedere la differenza al momento dell'ordine



S.P. 231 (Ex S.S. 98) Km. 79+850 - 70026 MODUGNO (BA)  
 http://www.cmvisrl.com - email: info@cmvisrl.com  
 Tel.: 080 - 5358899 - Fax: 080 - 5358909  
 P.IVA: 05329520729

**MONTANTI**

**MONTANTE SFILABILE RIBALTABILE  
 SPESSORE mm 33**

**4 LEVE - 2 CHIUSURE**

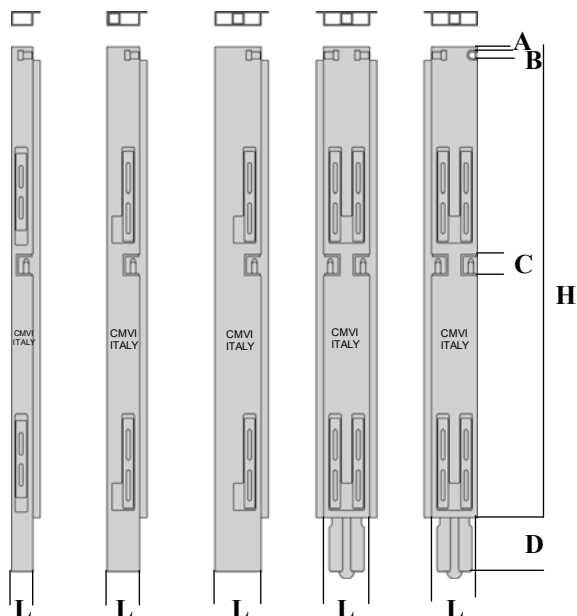

**Caratteristiche Tecniche**

H.	A	B	C	D	
1100	12	32	55	140	
1200	12	32	55	140	

FERRO	INOX 304 PARZIALE	INOX 304* TOTALE	INOX 304 P. FIORET.	INOX 304 T. FIORET.	DESCRIZIONE	H.	L.	PESO gr
C011180D	C021180D	C031180D	C021180DF	C031180DF	Anteriore DX	1100	56	
C011180S	C021180S	C031180S	C021180SF	C031180SF	Anteriore SX	1100	56	
C010180D	C020180D	C030180D	C020180DF	C030180DF	Anteriore DX	1100	85	
C010180S	C020180S	C030180S	C020180SF	C030180SF	Anteriore SX	1100	85	
C010181D	C020181D	C030181D	C020181DF	C030181DF	Anteriore DX	1100	120	
C010181S	C020181S	C030181S	C020181SF	C030181SF	Anteriore SX	1100	120	
C010182	C020182	C030182	C020182F	C030182F	Centrale	1100	120	
C010183D	C020183D	C030183D	C020183DF	C030183DF	Posteriore DX	1100	120	
C010183S	C020183S	C030183S	C020183SF	C030183SF	Posteriore SX	1100	120	

C011184D	C021184D	C031184D	C021184DF	C031184DF	Anteriore DX	1200	56	
C011184S	C021184S	C031184S	C021184SF	C031184SF	Anteriore SX	1200	56	
C010184D	C020184D	C030184D	C020184DF	C030184DF	Anteriore DX	1200	85	
C010184S	C020184S	C030184S	C020184SF	C030184SF	Anteriore SX	1200	85	
C010185D	C020185D	C030185D	C020185DF	C030185DF	Anteriore DX	1200	120	
C010185S	C020185S	C030185S	C020185SF	C030185SF	Anteriore SX	1200	120	
C010186	C020186	C030186	C020186F	C030186F	Centrale	1200	120	
C010187D	C020187D	C030187D	C020187DF	C030187DF	Posteriore DX	1200	120	
C010187S	C020187S	C030187S	C020187SF	C030187SF	Posteriore SX	1200	120	

\* N.B. Il montante ad innesto totalmente inox è fornito con la sede e l'innesto in FERRO.  
 Per la sede e l'innesto inox chiedere la differenza al momento dell'ordine



S.P. 231 (Ex S.S. 98) Km. 79+850 - 70026 MODUGNO (BA)  
<http://www.cmvisrl.com> - email: [info@cmvisrl.com](mailto:info@cmvisrl.com)  
 Tel.: 080 - 5358899 - Fax: 080 - 5358909  
 P.IVA: 05329520729

**MONTANTI**

**MONTANTE ROVESCIBILE SFILABILE  
 RIBALTABILE SPESSORE mm 33**

**PARI SOPRA**

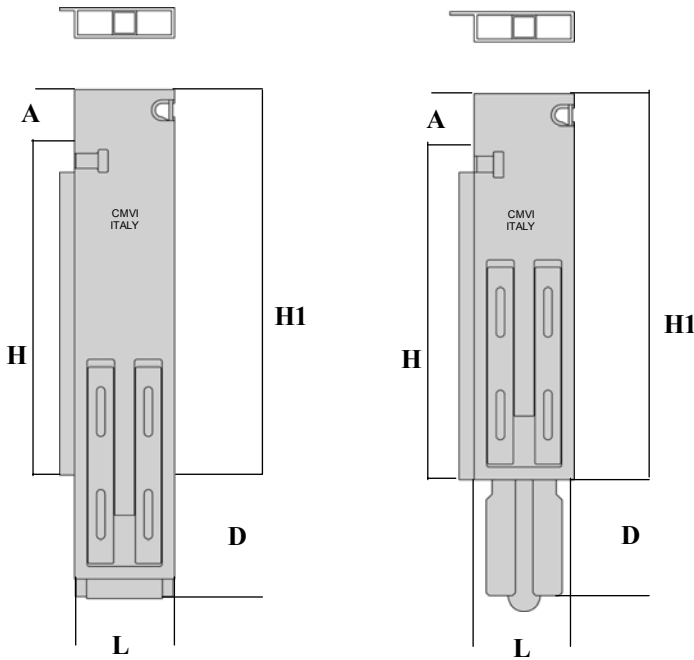

**Caratteristiche Tecniche**

A	D				
100	140				
100	140				

FERRO	INOX 304 PARZIALE	INOX 304* TOTALE	INOX 304 P. FIORET.	INOX 304 T. FIORET.	DESCRIZIONE	H/H1	L.	PESO gr
D033155D	D035155D	D039155D	D035155DF	D039155DF	POST. R. R.	400/500	120	
D033155S	D035155S	D039155S	D035155SF	D039155SF	POST. R. R.	400/500	120	
D033159D	D035159D	D039159D	D035159DF	D039159DF	POST. R. R.	500/600	120	
D033159S	D035159S	D039159S	D035159SF	D039159SF	POST. R. R.	500/600	120	
D033163D	D035163D	D039163D	D035163DF	D039163DF	POST. R. R.	600/700	120	
D033163S	D035163S	D039163S	D035163SF	D039163SF	POST. R. R.	600/700	120	
D033167D	D035167D	D039167D	D035167DF	D039167DF	POST. R. R.	700/800	120	
D033167S	D035167S	D039167S	D035167SF	D039167SF	POST. R. R.	700/800	120	

D031155D	D037155D	D041155D	D037155DF	D041155DF	POST. SFIL.	400/500	120	
D031155S	D037155S	D041155S	D037155SF	D041155SF	POST. SFIL.	400/500	120	
D031159D	D037159D	D041159D	D037159DF	D041159DF	POST. SFIL.	500/600	120	
D031159S	D037159S	D041159S	D037159SF	D041159SF	POST. SFIL.	500/600	120	
D031163D	D037163D	D041163D	D037163DF	D041163DF	POST. SFIL.	600/700	120	
D031163S	D037163S	D041163S	D037163SF	D041163SF	POST. SFIL.	600/700	120	
D031167D	D037167D	D041167D	D037167DF	D041167DF	POST. SFIL.	700/800	120	
D031167S	D037167S	D041167S	D037167SF	D041167SF	POST. SFIL.	700/800	120	

\* N.B. Il montante ad innesto totalmente inox è fornito con la sede e l'innesto in FERRO.  
 Per la sede e l'innesto inox chiedere la differenza al momento dell'ordine



S.P. 231 (Ex S.S. 98) Km. 79+850 - 70026 MODUGNO (BA)  
 http://www.cmvisrl.com - email: info@cmvisrl.com  
 Tel.: 080 - 5358899 - Fax: 080 - 5358909  
 P.IVA: 05329520729

**MONTANTI**

**MONTANTE ROVESCIBILE SFILABILE  
 RIBALTABILE SPESSORE mm 33**

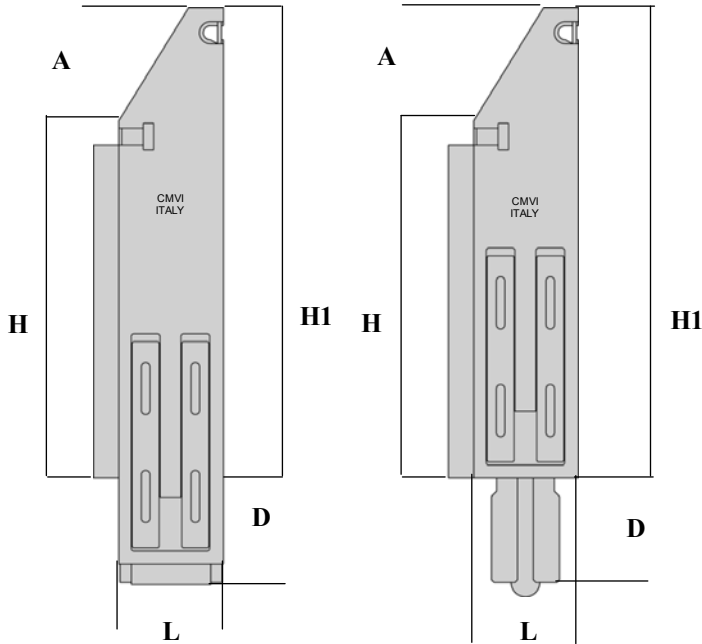

**SMUSSATI**

**Caratteristiche Tecniche**

A	B	D			
125	32	140			
125	32	140			

FERRO	INOX 304 PARZIALE	INOX 304 TOTALE	INOX 304 P. FIORET.	INOX 304 T. FIORET.	DESCRIZIONE	H/H1	L.	PESO gr
D034155D	D036155D	D040155D	D036155DF	D040155DF	POST. R. R.	400/525	120	
D034155S	D036155S	D040155S	D036155SF	D040155SF	POST. R. R.	400/525	120	
D034159D	D036159D	D040159D	D036159DF	D040159DF	POST. R. R.	500/625	120	
D034159S	D036159S	D040159S	D036159SF	D040159SF	POST. R. R.	500/625	120	
D034163D	D036163D	D040163D	D036163DF	D040163DF	POST. R. R.	600/725	120	
D034163S	D036163S	D040163S	D036163SF	D040163SF	POST. R. R.	600/725	120	
D034167D	D036167D	D040167D	D036167DF	D040167DF	POST. R. R.	700/825	120	
D034167S	D036167S	D040167S	D036167SF	D040167SF	POST. R. R.	700/825	120	

D032155D	D038155D	D042155D	D038155DF	D042155DF	POST. SFIL.	400/525	120	
D032155S	D038155S	D042155S	D038155SF	D042155SF	POST. SFIL.	400/525	120	
D032159D	D038159D	D042159D	D038159DF	D042159DF	POST. SFIL.	500/625	120	
D032159S	D038159S	D042159S	D038159SF	D042159SF	POST. SFIL.	500/625	120	
D032163D	D038163D	D042163D	D038163DF	D042163DF	POST. SFIL.	600/725	120	
D032163S	D038163S	D042163S	D038163SF	D042163SF	POST. SFIL.	600/725	120	
D032167D	D038167D	D042167D	D038167DF	D042167DF	POST. SFIL.	700/825	120	
D032167S	D038167S	D042167S	D038167SF	D042167SF	POST. SFIL.	700/825	120	

\* N.B. Il montante ad innesto totalmente inox è fornito con la sede e l'innesto in FERRO.  
 Per la sede e l'innesto inox chiedere la differenza al momento dell'ordine





S.P. 231 (Ex S.S. 98) Km. 79+850 - 70026 MODUGNO (BA)  
 http://www.cmvisrl.com - email: info@cmvisrl.com  
 Tel.: 080 - 5358899 - Fax: 080 - 5358909  
 P.IVA: 05329520729

**MONTANTI**

**MONTANTE SFILABILE RIBALTABILE CON  
 INNESTO LEGGERO SPESSORE mm 33**

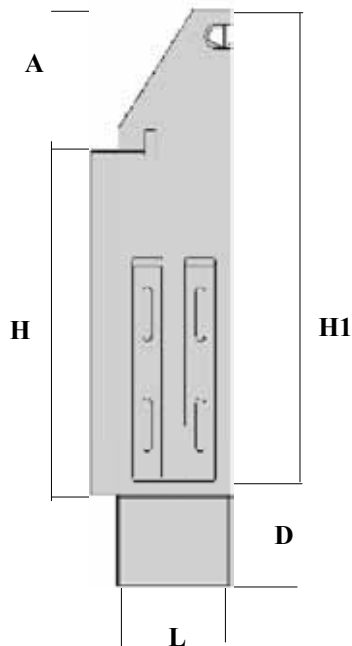

SMUSSATO

**Caratteristiche Tecniche**

A	B	D			
100	32	100			
125	32	100			

FERRO	INOX 304 PARZIALE	INOX 304 TOTALE	INOX 304 P. FIORET.	INOX 304 T. FIORET.	DESCRIZIONE	H/H1	L.	PESO gr
CODICE	CODICE	CODICE	CODICE	CODICE				
D032168D					POST. SFIL.	400/500	120	
D032168S					POST. SFIL.	400/500	120	
D032169D					POST. SFIL.	500/600	120	
D032169S					POST. SFIL.	500/600	120	
D032170D					POST. SFIL.	600/700	120	
D032170S					POST. SFIL.	600/700	120	
D032171D					POST. SFIL.	700/800	120	
D032171S					POST. SFIL.	700/800	120	

D032172D					POST. SFIL.	400/525	120	
D032172S					POST. SFIL.	400/525	120	
D032173D					POST. SFIL.	500/625	120	
D032173S					POST. SFIL.	500/625	120	
D032174D					POST. SFIL.	600/725	120	
D032174S					POST. SFIL.	600/725	120	
D032175D					POST. SFIL.	700/825	120	
D032175S					POST. SFIL.	700/825	120	

\* N.B. Il montante ad innesto totalmente inox è fornito con la sede e l'innesto in FERRO.  
 Per la sede e l'innesto inox chiedere la differenza al momento dell'ordine



S.P. 231 (Ex S.S. 98) Km. 79+850 - 70026 MODUGNO (BA)  
<http://www.cmvisrl.com> - email: [info@cmvisrl.com](mailto:info@cmvisrl.com)  
 Tel.: 080 - 5358899 - Fax: 080 - 5358909  
 P.IVA: 05329520729

**MONTANTI**

**MONTANTE SFILABILE RIBALTABILE CON  
 INNESTO LEGGERO **SPESORE mm 33****

**PARI SOPRA**

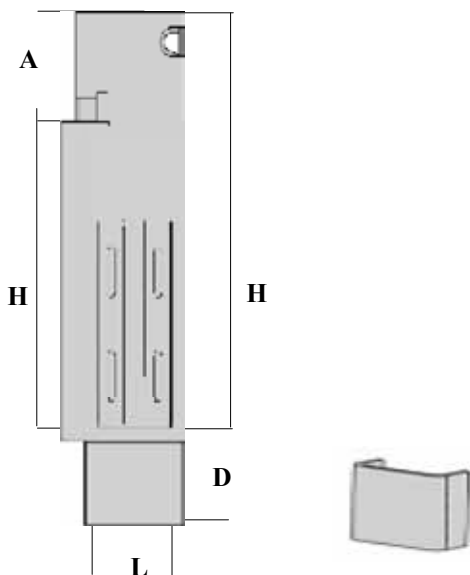

**Caratteristiche Tecniche**

A	B	D			
100		100			
100		100			

FERRO	INOX 304 PARZIALE	INOX 304 TOTALE	INOX 304 P. FIORET.	INOX 304 T. FIORET.	DESCRIZIONE	H/H1	L.	PESO gr
<b>D032176D</b>					<b>POST. SFIL.</b>	<b>400/500</b>	<b>120</b>	
<b>D032176S</b>					<b>POST. SFIL.</b>	<b>400/500</b>	<b>120</b>	
<b>D032177D</b>					<b>POST. SFIL.</b>	<b>500/600</b>	<b>120</b>	
<b>D032177S</b>					<b>POST. SFIL.</b>	<b>500/600</b>	<b>120</b>	
<b>D032178D</b>					<b>POST. SFIL.</b>	<b>600/700</b>	<b>120</b>	
<b>D032178S</b>					<b>POST. SFIL.</b>	<b>600/700</b>	<b>120</b>	
<b>D032179D</b>					<b>POST. SFIL.</b>	<b>700/800</b>	<b>120</b>	
<b>D032179S</b>					<b>POST. SFIL.</b>	<b>700/800</b>	<b>120</b>	

<b>D032180</b>					<b>CENT. SFIL.</b>	<b>400</b>	<b>120</b>	
<b>D032181D</b>					<b>POST. SFIL.</b>	<b>400</b>	<b>120</b>	
<b>D032181S</b>					<b>POST. SFIL.</b>	<b>400</b>	<b>120</b>	
<b>D032182</b>					<b>CENT. SFIL.</b>	<b>500</b>	<b>120</b>	
<b>D032183D</b>					<b>POST. SFIL.</b>	<b>500</b>	<b>120</b>	
<b>D032183S</b>					<b>POST. SFIL.</b>	<b>500</b>	<b>120</b>	
<b>D032184</b>					<b>POST. SFIL.</b>	<b>600</b>	<b>120</b>	
<b>D032185D</b>					<b>POST. SFIL.</b>	<b>600</b>	<b>120</b>	
<b>D032185S</b>					<b>POST. SFIL.</b>	<b>600</b>	<b>120</b>	



S.P. 231 (Ex S.S. 98) Km. 79+850 - 70026 MODUGNO (BA)  
 http://www.cmvisrl.com - email: info@cmvisrl.com  
 Tel.: 080 - 5358899 - Fax: 080 - 5358909  
 P.IVA: 05329520729

**MONTANTI**

**MONTANTE SFILABILE RIBALTABILE CON  
 INNESTO LEGGERO SPESSORE mm 33**

**PARI SOPRA**

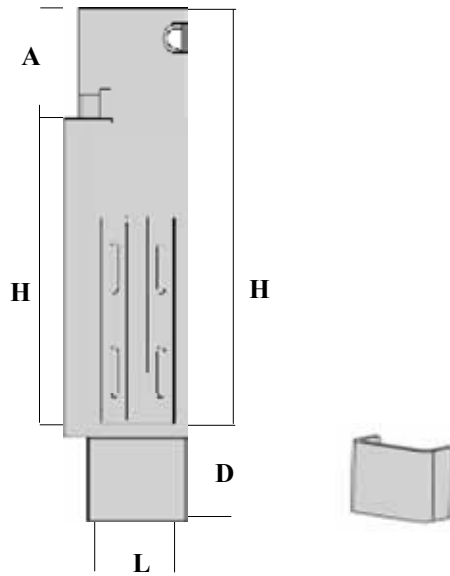

**Caratteristiche Tecniche**

A	B	D			
125		100			
125		100			

FERRO	INOX 304 PARZIALE	INOX 304 TOTALE	INOX 304 P. FIORET.	INOX 304 T. FIORET.	DESCRIZIONE	H/H1	L.	PESO gr
CODICE	CODICE	CODICE	CODICE	CODICE				
D032186D					POST. SFIL.	400/525	120	
D032186S					POST. SFIL.	400/525	120	
D032187D					POST. SFIL.	500/625	120	
D032187S					POST. SFIL.	500/625	120	
D032188D					POST. SFIL.	600/725	120	
D032188S					POST. SFIL.	600/725	120	
D032189D					POST. SFIL.	700/825	120	
D032189S					POST. SFIL.	700/825	120	



S.P. 231 (Ex S.S. 98) Km. 79+850 - 70026 MODUGNO (BA)  
 http://www.cmvisrl.com - email: info@cmvisrl.com  
 Tel.: 080 - 5358899 - Fax: 080 - 5358909  
 P.IVA: 05329520729

MONTANTI

MONTANTE ROVESCIBILE FISSO RIBALTABILE  
 CON SNODO SUPERIORE **SPESSORE mm 33**

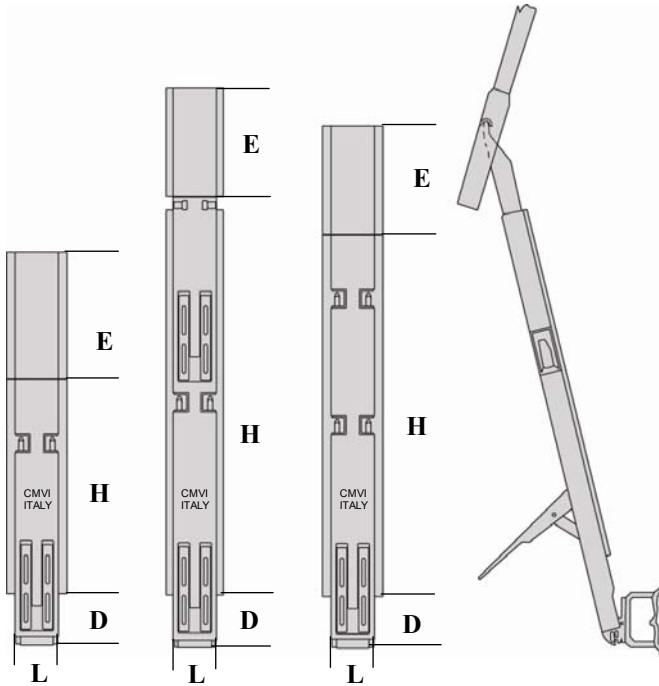

Caratteristiche Tecniche

	D	E			
C.F.	140	250			
R.R.	140	250			

FERRO	INOX 304 PARZIALE	INOX 304 TOTALE	INOX 304 P. FIORET.	INOX 304 T. FIORET.	DESCRIZIONE	H.	L.	PESO gr
E010307	E020307	E030307	E020307F	E030307F	C. FISSO	500	120	
E010313	E020313	E030313	E020313F	E030313F	C. FISSO	600	120	
E009319	E019319	E029319	E019319F	E029319F	C. FISSO	700	120	
E010319	E020319	E030319	E020319F	E030319F	C. FISSO	800	120	
E009325	E019325	E029325	E019325F	E029325F	C. FISSO	900	120	
E010325	E020325	E030325	E020325F	E030325F	C. FISSO	1000	120	
E010331	E020331	E030331	E020331F	E030331F	C. FISSO	1100	120	
E010337	E020337	E030337	E020337F	E030337F	C. FISSO	1200	120	

E007307	E021307	E031307	E021307F	E031307F	R. RIBALTAB.	500	120	
E007313	E021313	E031313	E021313F	E031313F	R. RIBALTAB.	600	120	
E007319	E021319	E031319	E021319F	E031319F	R. RIBALTAB.	700	120	
E007325	E021325	E031325	E021325F	E031325F	R. RIBALTAB.	800	120	
E007331	E021331	E031331	E021331F	E031331F	R. RIBALTAB.	900	120	
E007337	E021337	E031337	E021337F	E031337F	R. RIBALTAB.	1000	120	
E008337	E022337	E032337	E022337F	E032337F	R. RIBALTAB.	1100	120	
E009337	E023337	E033337	E023337F	E033337F	R. RIBALTAB.	1200	120	



S.P. 231 (Ex S.S. 98) Km. 79+850 - 70026 MODUGNO (BA)  
 http://www.cmvisrl.com - email: info@cmvisrl.com  
 Tel.: 080 - 5358899 - Fax: 080 - 5358909  
 P.IVA: 05329520729

**MONTANTI**

**MONTANTE SPONDA POSTERIORE**  
**SPESSORE mm 33**

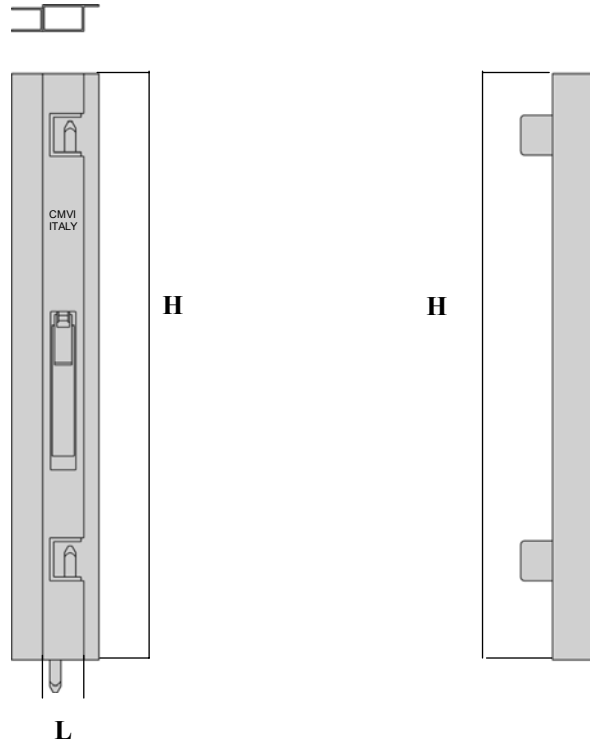

**Terminale Montante Unilaterale**

FERRO					ACCIAIO ZINCATO				
CODICE	DESCRIZIONE	H.	L.	PESO gr	CODICE	DESCRIZIONE	H.	L.	PESO gr
E010290	Chiusura sponda posteriore	600	56		E010293	Chiusura posteriore	600		
E010291	Chiusura sponda posteriore	800	56		E010294	Chiusura posteriore	800		
E010292	Chiusura sponda posteriore	1000	56		E010295	Chiusura posteriore	1000		



S.P. 231 (Ex S.S. 98) Km. 79+850 - 70026 MODUGNO (BA)  
<http://www.cmvisrl.com> - email: [info@cmvisrl.com](mailto:info@cmvisrl.com)  
 Tel.: 080 - 5358899 - Fax: 080 - 5358909  
 P.IVA: 05329520729

**MONTANTI**

**MONTANTE GRAN VOLUME**  
**SPESSORE mm 33**

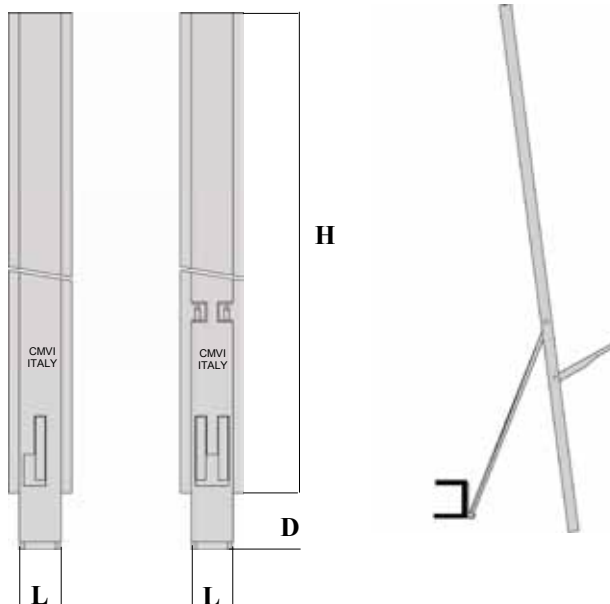

FERRO	INOX 304 PARZIALE	INOX 304 TOTALE	INOX 304 P. FIORET.	INOX 304 T. FIORET.				
CODICE	CODICE	CODICE	CODICE	CODICE	DESCRIZIONE	H.	L.	D
E010296	E013296	E011296	E013296F	E011296F	1 LEVA	2800	120	140
E012297	E013297	E011297	E013297F	E011297F	2 LEVE x 600	2800	120	140
E012298	E013298	E011298	E013298F	E011298F	2 LEVE x 800	2800	120	140
E012299	E013299	E011299	E013299F	E011299F	2 LEVE x 1000	2800	120	140



S.P. 231 (Ex S.S. 98) Km. 79+850 - 70026 MODUGNO (BA)  
<http://www.cmvisrl.com> - email: [info@cmvisrl.com](mailto:info@cmvisrl.com)  
 Tel.: 080 - 5358899 - Fax: 080 - 5358909  
 P.IVA: 05329520729

**MONTANTI**

**MONTANTE GRAN VOLUME CORTO**  
**SPESSORE mm 33**

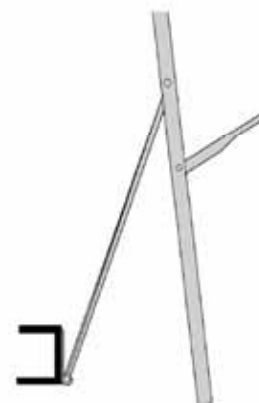
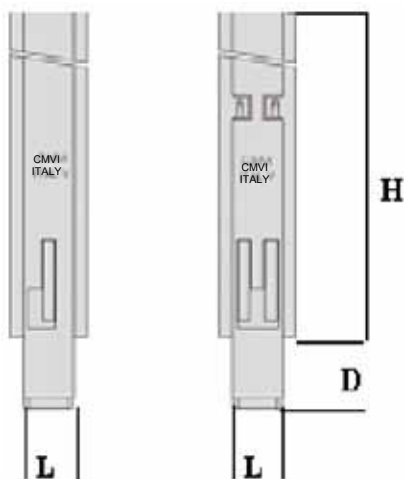
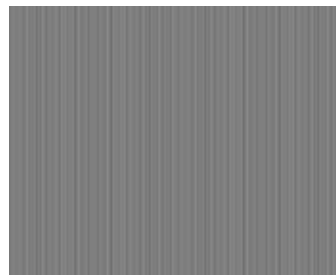

FERRO	INOX 304 PARZIALE	INOX 304 TOTALE	INOX 304 P. FIORET.	INOX 304 T. FIORET.	DESCRIZIONE	H.	L.	D
E012300	E013300	E011300	E013300F	E011300F	1 LEVA	800	120	140
E012301	E013301	E011301	E013301F	E011301F	2 LEVE x 600	800	120	140
E012302	E013302	E011302	E013302F	E011302F	2 LEVE x 800	800	120	140
E012303	E013303	E011303	E013303F	E011303F	2 LEVE x 1000	1000	120	140

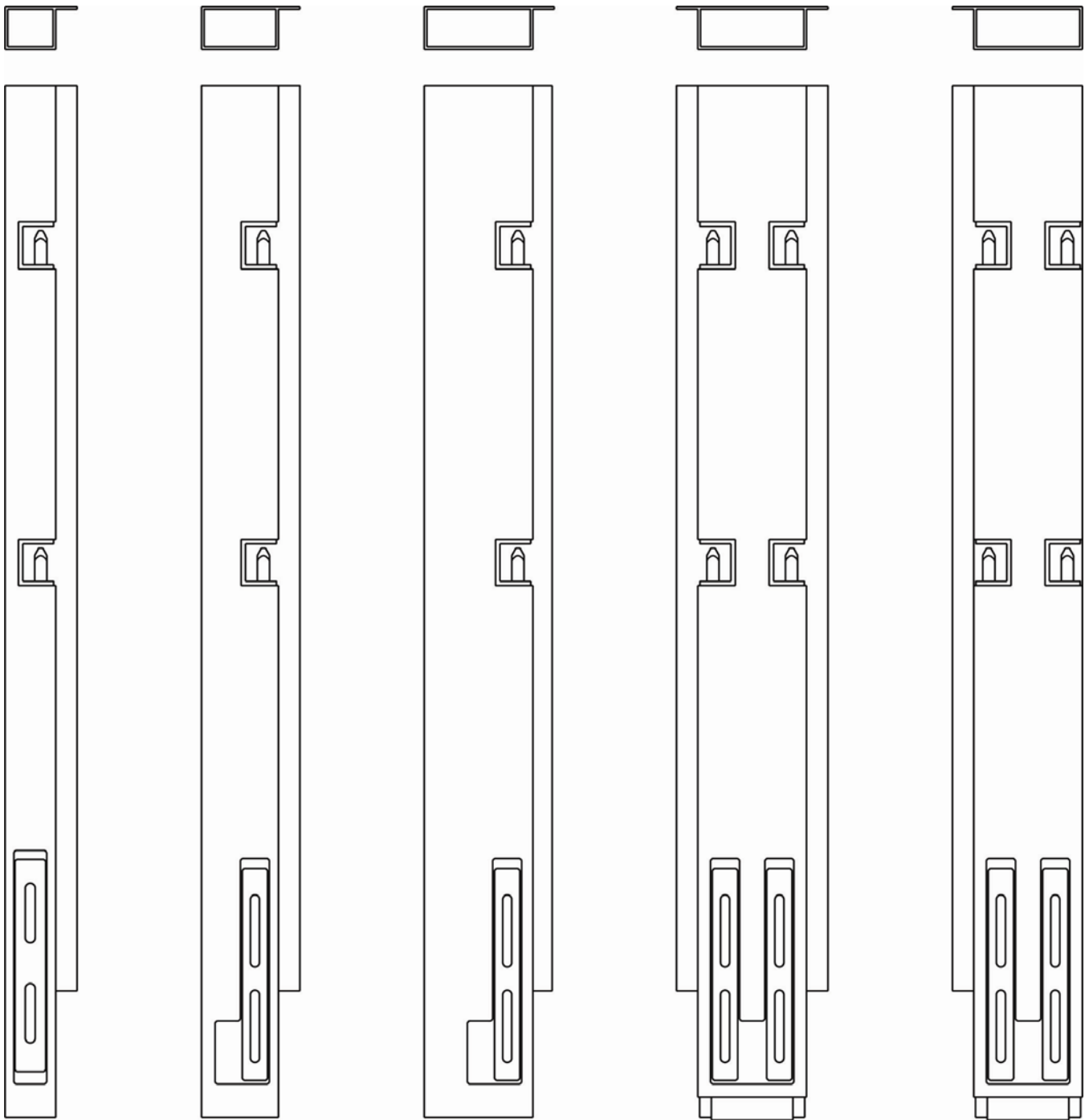

MONTANTI SERIE CMVI SPESSORE mm. 41





S.P. 231 (Ex S.S. 98) Km. 79+850 - 70026 MODUGNO (BA)  
<http://www.cmvisrl.com> - email: [info@cmvisrl.com](mailto:info@cmvisrl.com)  
 Tel.: 080 - 5358899 - Fax: 080 - 5358909  
 P.IVA: 05329520729

**MONTANTI**

**MONTANTE ROVESCIBILE FISSO**  
**SPESORE mm 41**

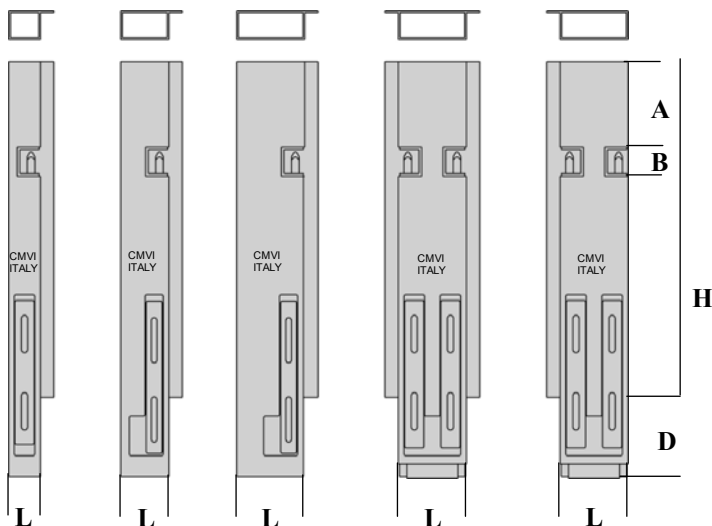

**Caratteristiche Tecniche**

H.	A	B	D		
400	50	55	140		
500	150	55	140		

FERRO	INOX 304 PARZIALE	INOX 304 TOTALE	INOX 304 P. FIORET.	INOX 304 T. FIORET.	DESCRIZIONE	H.	L.	PESO gr
<b>E070297D</b>	<b>E075297D</b>	<b>E080297D</b>	<b>E075297DF</b>	<b>E080297DF</b>	Anteriore DX	400	56	
<b>E070297S</b>	<b>E075297S</b>	<b>E080297S</b>	<b>E075297SF</b>	<b>E080297SF</b>	Anteriore SX	400	56	
<b>E070298D</b>	<b>E075298D</b>	<b>E080298D</b>	<b>E075298DF</b>	<b>E080298DF</b>	Anteriore DX	400	85	
<b>E070298S</b>	<b>E075298S</b>	<b>E080298S</b>	<b>E075298SF</b>	<b>E080298SF</b>	Anteriore SX	400	85	
<b>E070299D</b>	<b>E075299D</b>	<b>E080299D</b>	<b>E075299DF</b>	<b>E080299DF</b>	Anteriore DX	400	120	
<b>E070299S</b>	<b>E075299S</b>	<b>E080299S</b>	<b>E075299SF</b>	<b>E080299SF</b>	Anteriore SX	400	120	
<b>E070300</b>	<b>E075300</b>	<b>E080300</b>	<b>E075300F</b>	<b>E080300F</b>	Centrale	400	120	
<b>E070301D</b>	<b>E075301D</b>	<b>E080301D</b>	<b>E075301DF</b>	<b>E080301DF</b>	Posteriore DX	400	120	
<b>E070301S</b>	<b>E075301S</b>	<b>E080301S</b>	<b>E075301SF</b>	<b>E080301SF</b>	Posteriore SX	400	120	

<b>E070302D</b>	<b>E075302D</b>	<b>E080302D</b>	<b>E075302DF</b>	<b>E080302DF</b>	Anteriore DX	500	56	
<b>E070302S</b>	<b>E075302S</b>	<b>E080302S</b>	<b>E075302SF</b>	<b>E080302SF</b>	Anteriore SX	500	56	
<b>E070303D</b>	<b>E075303D</b>	<b>E080303D</b>	<b>E075303DF</b>	<b>E080303DF</b>	Anteriore DX	500	85	
<b>E070303S</b>	<b>E075303S</b>	<b>E080303S</b>	<b>E075303SF</b>	<b>E080303SF</b>	Anteriore SX	500	85	
<b>E070304D</b>	<b>E075304D</b>	<b>E080304D</b>	<b>E075304DF</b>	<b>E080304DF</b>	Anteriore DX	500	120	
<b>E070304S</b>	<b>E075304S</b>	<b>E080304S</b>	<b>E075304SF</b>	<b>E080304SF</b>	Anteriore SX	500	120	
<b>E070305</b>	<b>E075305</b>	<b>E080305</b>	<b>E075305F</b>	<b>E080305F</b>	Centrale	500	120	
<b>E070306D</b>	<b>E075306D</b>	<b>E080306D</b>	<b>E075306DF</b>	<b>E080306DF</b>	Posteriore DX	500	120	
<b>E070306S</b>	<b>E075306S</b>	<b>E080306S</b>	<b>E075306SF</b>	<b>E080306SF</b>	Posteriore SX	500	120	



S.P. 231 (Ex S.S. 98) Km. 79+850 - 70026 MODUGNO (BA)  
 http://www.cmvisrl.com - email: info@cmvisrl.com  
 Tel.: 080 - 5358899 - Fax: 080 - 5358909  
 P.IVA: 05329520729

**MONTANTI**

## MONTANTE ROVESCIBILE FISSO SPESSORE mm 41

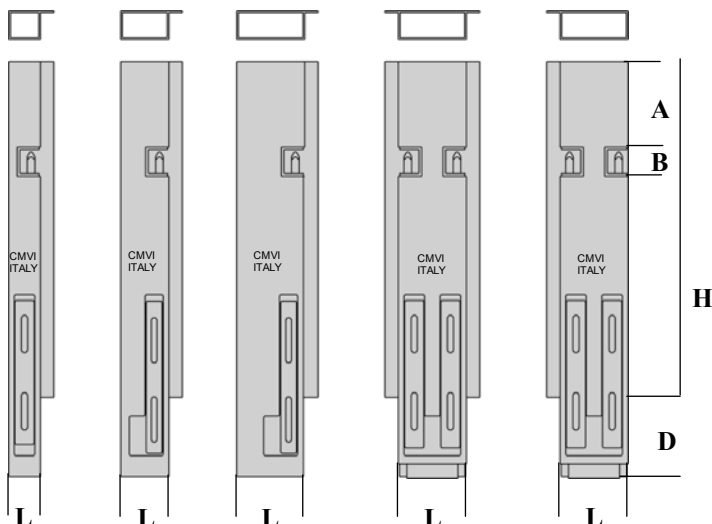

### Caratteristiche Tecniche

H.	A	B	D		
600	150	55	140		
700	150	55	140		

FERRO	INOX 304 PARZIALE	INOX 304 TOTALE	INOX 304 P. FIORET.	INOX 304 T. FIORET.				
CODICE	CODICE	CODICE	CODICE	CODICE	DESCRIZIONE	H.	L.	PESO gr
E070308D	E075308D	E080308D	E075308DF	E080308DF	Anteriore DX	600	56	
E070308S	E075308S	E080308S	E075308SF	E080308SF	Anteriore SX	600	56	
E070309D	E075309D	E080309D	E075309DF	E080309DF	Anteriore DX	600	85	
E070309S	E075309S	E080309S	E075309SF	E080309SF	Anteriore SX	600	85	
E070310D	E075310D	E080310D	E075310DF	E080310DF	Anteriore DX	600	120	
E070310S	E075310S	E080310S	E075310SF	E080310SF	Anteriore SX	600	120	
E070311	E075311	E080311	E075311F	E080311F	Centrale	600	120	
E070312D	E075312D	E080312D	E075312DF	E080312DF	Posteriore DX	600	120	
E070312S	E075312S	E080312S	E075312SF	E080312SF	Posteriore SX	600	120	

E070314D	E075314D	E080314D	E075314DF	E080314DF	Anteriore DX	700	56	
E070314S	E075314S	E080314S	E075314SF	E080314SF	Anteriore SX	700	56	
E070315D	E075315D	E080315D	E075315DF	E080315DF	Anteriore DX	700	85	
E070315S	E075315S	E080315S	E075315SF	E080315SF	Anteriore SX	700	85	
E070316D	E075316D	E080316D	E075316DF	E080316DF	Anteriore DX	700	120	
E070316S	E075316S	E080316S	E075316SF	E080316SF	Anteriore SX	700	120	
E070317D	E075317	E080317	E075317F	E080317F	Centrale	700	120	
E070318D	E075318D	E080318D	E075318DF	E080318DF	Posteriore DX	700	120	
E070318S	E075318S	E080318S	E075318SF	E080318SF	Posteriore SX	700	120	



S.P. 231 (Ex S.S. 98) Km. 79+850 - 70026 MODUGNO (BA)  
<http://www.cmvisrl.com> - email: [info@cmvisrl.com](mailto:info@cmvisrl.com)  
 Tel.: 080 - 5358899 - Fax: 080 - 5358909  
 P.IVA: 05329520729

**MONTANTI**

## MONTANTE ROVESCIBILE FISSO SPESSORE mm 41

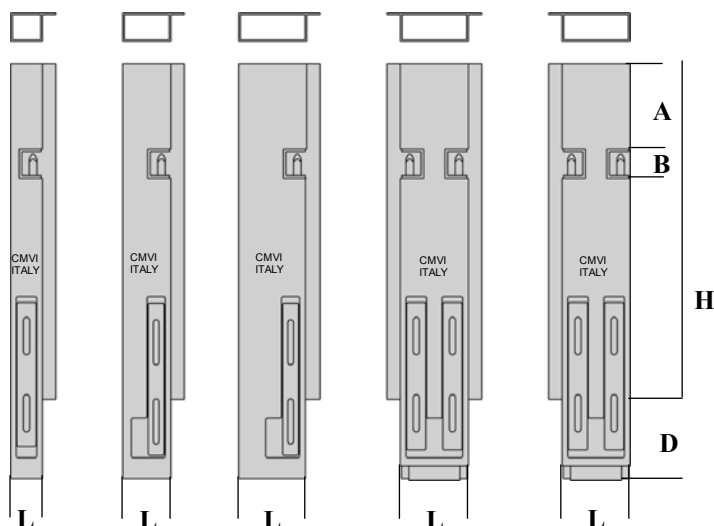

### Caratteristiche Tecniche

H.	A	B	D		
800	150	55	140		
900	150	55	140		

FERRO	INOX 304 PARZIALE	INOX 304 TOTALE	INOX 304 P. FIORET.	INOX 304 T. FIORET.	DESCRIZIONE	H.	L.	PESO gr
E070320D	E075320D	E080320D	E075320DF	E080320DF	Anteriore DX	800	56	
E070320S	E075320S	E080320S	E075320SF	E080320SF	Anteriore SX	800	56	
E070321D	E075321D	E080321D	E075321DF	E080321DF	Anteriore DX	800	85	
E070321S	E075321S	E080321S	E075321SF	E080321SF	Anteriore SX	800	85	
E070322D	E075322D	E080322D	E075322DF	E080322DF	Anteriore DX	800	120	
E070322S	E075322S	E080322S	E075322SF	E080322SF	Anteriore SX	800	120	
E070323	E075323	E080323	E075323F	E080323F	Centrale	800	120	
E070324D	E075324D	E080324D	E075324DF	E080324DF	Posteriore DX	800	120	
E070324S	E075324S	E080324S	E075324SF	E080324SF	Posteriore SX	800	120	

E070326D	E075326D	E080326D	E075326DF	E080326DF	Anteriore DX	900	56	
E070326S	E075326S	E080326S	E075326SF	E080326SF	Anteriore SX	900	56	
E070327D	E075327D	E080327D	E075327DF	E080327DF	Anteriore DX	900	85	
E070327S	E075327S	E080327S	E075327SF	E080327SF	Anteriore SX	900	85	
E070328D	E075328D	E080328D	E075328DF	E080328DF	Anteriore DX	900	120	
E070328S	E075328S	E080328S	E075328SF	E080328SF	Anteriore SX	900	120	
E070329	E075329	E080329	E075329F	E080329F	Centrale	900	120	
E070330D	E075330D	E080330D	E075330DF	E080330DF	Posteriore DX	900	120	
E070330S	E075330S	E080330S	E075330SF	E080330SF	Posteriore SX	900	120	



S.P. 231 (Ex S.S. 98) Km. 79+850 - 70026 MODUGNO (BA)  
<http://www.cmvisrl.com> - email: [info@cmvisrl.com](mailto:info@cmvisrl.com)  
 Tel.: 080 - 5358899 - Fax: 080 - 5358909  
 P.IVA: 05329520729

MONTANTI

## MONTANTE ROVESCIBILE FISSO SPESSORE mm 41

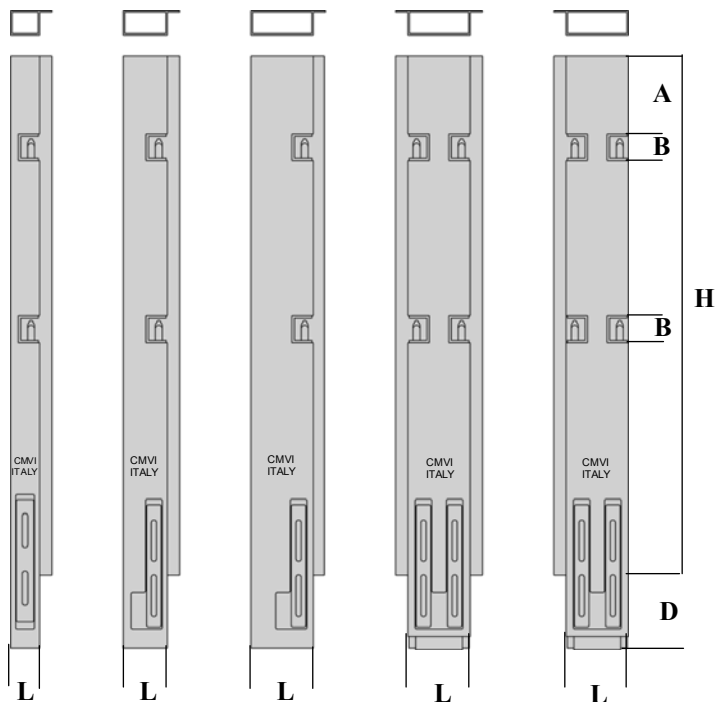

### Caratteristiche Tecniche

H.	A	B	D		
1000	150	55	140		
1100	150	55	140		

FERRO	INOX 304 PARZIALE	INOX 304 TOTALE	INOX 304 P. FIORET.	INOX 304 T. FIORET.	DESCRIZIONE	H.	L.	PESO gr
E070332D	E075332D	E080332D	E075332DF	E080332DF	Anteriore DX	1000	56	
E070332S	E075332S	E080332S	E075332SF	E080332SF	Anteriore SX	1000	56	
E070333D	E075333D	E080333D	E075333DF	E080333DF	Anteriore DX	1000	85	
E070333S	E075333S	E080333S	E075333SF	E080333SF	Anteriore SX	1000	85	
E070334D	E075334D	E080334D	E075334DF	E080334DF	Anteriore DX	1000	120	
E070334S	E075334S	E080334S	E075334SF	E080334SF	Anteriore SX	1000	120	
E070335	E075335	E080335	E075335F	E080335F	Centrale	1000	120	
E070336D	E075336D	E080336D	E075336DF	E080336DF	Posteriore DX	1000	120	
E070336S	E075336S	E080336S	E075336SF	E080336SF	Posteriore SX	1000	120	

E070338D	E075338D	E080338D	E075338DF	E080338DF	Anteriore DX	1100	56	
E070338S	E075338S	E080338S	E075338SF	E080338SF	Anteriore SX	1100	56	
E070339D	E075339D	E080339D	E075339DF	E080339DF	Anteriore DX	1100	85	
E070339S	E075339S	E080339S	E075339SF	E080339SF	Anteriore SX	1100	85	
E070340D	E075340D	E080340D	E075340DF	E080340DF	Anteriore DX	1100	120	
E070340S	E075340S	E080340S	E075340SF	E080340SF	Anteriore SX	1100	120	
E070341	E075341	E080341	E075341F	E080341F	Centrale	1100	120	
E070342D	E075342D	E080342D	E075342DF	E080342DF	Posteriore DX	1100	120	
E070342S	E075342S	E080342S	E075342SF	E080342SF	Posteriore SX	1100	120	



S.P. 231 (Ex S.S. 98) Km. 79+850 - 70026 MODUGNO (BA)  
<http://www.cmvisrl.com> - email: [info@cmvisrl.com](mailto:info@cmvisrl.com)  
 Tel.: 080 - 5358899 - Fax: 080 - 5358909  
 P.IVA: 05329520729

**MONTANTI**

## MONTANTE ROVESCIBILE FISSO SPESSORE mm 41

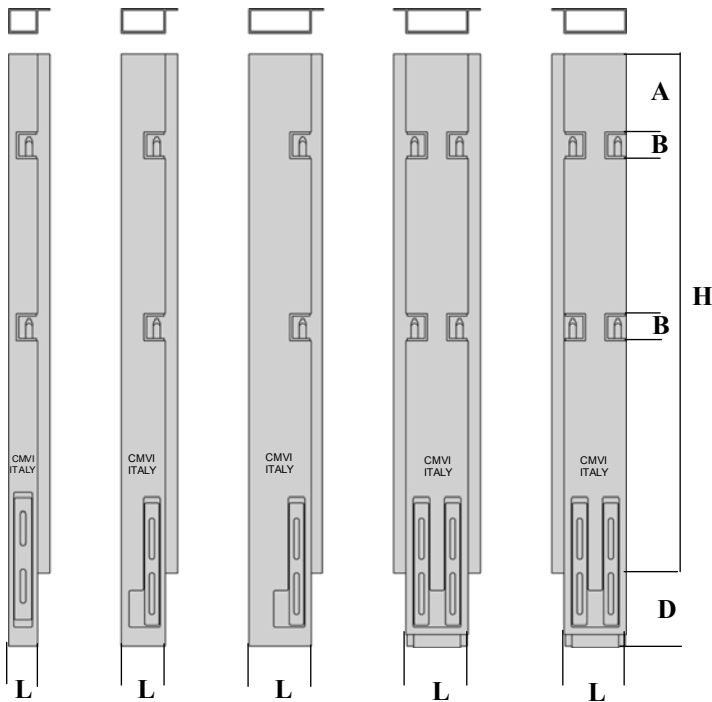

### Caratteristiche Tecniche

H.	A	B	D		
1200	150	55	140		

FERRO	INOX 304 PARZIALE	INOX 304 TOTALE	INOX 304 P. FIORET.	INOX 304 T. FIORET.	DESCRIZIONE	H.	L.	PESO gr
E070344D	E075344D	E080344D	E075344DF	E080344DF	Anteriore DX	1200	56	
E070344S	E075344S	E080344S	E075344SF	E080344SF	Anteriore SX	1200	56	
E070345D	E075345D	E080345D	E075345DF	E080345DF	Anteriore DX	1200	85	
E070345S	E075345S	E080345S	E075345SF	E080345SF	Anteriore SX	1200	85	
E070346D	E075346D	E080346D	E075346DF	E080346DF	Anteriore DX	1200	120	
E070346S	E075346S	E080346S	E075346SF	E080346SF	Anteriore SX	1200	120	
E070347	E075347	E080347	E075347F	E080347F	Centrale	1200	120	
E070348D	E075348D	E080348D	E075348DF	E080348DF	Posteriore DX	1200	120	
E070348S	E075348S	E080348S	E075348SF	E080348SF	Posteriore SX	1200	120	



S.P. 231 (Ex S.S. 98) Km. 79+850 - 70026 MODUGNO (BA)  
<http://www.cmvisrl.com> - email: [info@cmvisrl.com](mailto:info@cmvisrl.com)  
 Tel.: 080 - 5358899 - Fax: 080 - 5358909  
 P.IVA: 05329520729

MONTANTI

## MONTANTE INNESTO FISSO SPESSORE mm 41

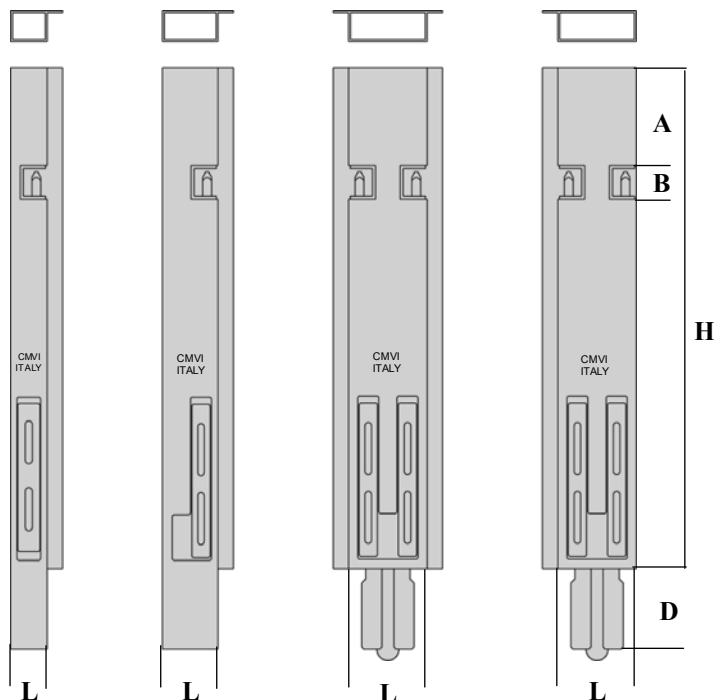

### Caratteristiche Tecniche

H.	A	B	D		
600	15	55	140		
870	15	55	140		

FERRO	INOX 304 PARZIALE	INOX 304* TOTALE	INOX 304 P. FIORET.	INOX 304 T. FIORET.				
CODICE	CODICE	CODICE	CODICE	CODICE	DESCRIZIONE	H.	L.	PESO gr
E070350D	E075350D	E080350D	E075350DF	E080350DF	Anteriore DX	600	56	
E070350S	E075350S	E080350S	E075350SF	E080350SF	Anteriore SX	600	56	
E070351D	E075351D	E080351D	E075351DF	E080351DF	Anteriore DX	600	85	
E070351S	E075351S	E080351S	E075351SF	E080351SF	Anteriore SX	600	85	
E070352	E075352	E080352	E075352F	E080352F	Centrale	600	120	
E070353D	E075353D	E080353D	E075353DF	E080353DF	Posteriore DX	600	120	
E070353S	E075353S	E080353S	E075353SF	E080353SF	Posteriore SX	600	120	

E070355D	E075355D	E080355D	E075355DF	E080355DF	Anteriore DX	800	56	
E070355S	E075355S	E080355S	E075355SF	E080355SF	Anteriore SX	800	56	
E070356D	E075356D	E080356D	E075356DF	E080356DF	Anteriore DX	800	85	
E070356S	E075356S	E080356S	E075356SF	E080356SF	Anteriore SX	800	85	
E070357	E075357	E080357	E075357F	E080357F	Centrale	800	120	
E070358D	E075358D	E080358D	E075358DF	E080358DF	Posteriore DX	800	120	
E070358S	E075358S	E080358S	E075358SF	E080358SF	Posteriore SX	800	120	

\* N.B. Il montante ad innesto totalmente inox è fornito con la sede e l'innesto in FERRO.  
 Per la sede e l'innesto inox chiedere la differenza al momento dell'ordine



S.P. 231 (Ex S.S. 98) Km. 79+850 - 70026 MODUGNO (BA)  
<http://www.cmvisrl.com> - email: [info@cmvisrl.com](mailto:info@cmvisrl.com)  
 Tel.: 080 - 5358899 - Fax: 080 - 5358909  
 P.IVA: 05329520729

MONTANTI

## MONTANTE INNESTO FISSO SPESSORE mm 41

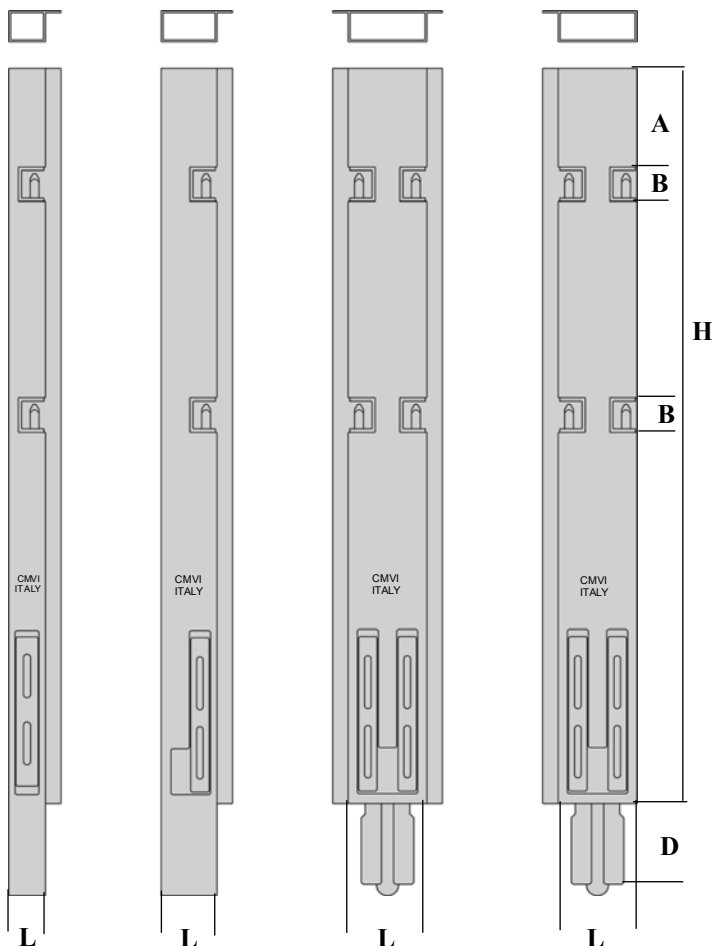

### Caratteristiche Tecniche

H.	A	B	D					
1000	15	55	140					
CODICE	CODICE	CODICE	CODICE	CODICE	DESCRIZIONE	H.	L.	PESO gr
<b>E070360D</b>	<b>E075360D</b>	<b>E080360D</b>	<b>E075360DF</b>	<b>E080360DF</b>	Anteriore DX	<b>1000</b>	<b>56</b>	
<b>E070360S</b>	<b>E075360S</b>	<b>E080360S</b>	<b>E075360SF</b>	<b>E080360SF</b>	Anteriore SX	<b>1000</b>	<b>56</b>	
<b>E070361D</b>	<b>E075361D</b>	<b>E080361D</b>	<b>E075361DF</b>	<b>E080361DF</b>	Anteriore DX	<b>1000</b>	<b>85</b>	
<b>E070361S</b>	<b>E075361S</b>	<b>E080361S</b>	<b>E075361SF</b>	<b>E080361SF</b>	Anteriore SX	<b>1000</b>	<b>85</b>	
<b>E070362</b>	<b>E075362</b>	<b>E080362</b>	<b>E075362F</b>	<b>E080362F</b>	Centrale	<b>1000</b>	<b>120</b>	
<b>E070363D</b>	<b>E075363D</b>	<b>E080363D</b>	<b>E075363DF</b>	<b>E080363DF</b>	Posteriore DX	<b>1000</b>	<b>120</b>	
<b>E070363S</b>	<b>E075363S</b>	<b>E080363S</b>	<b>E075363SF</b>	<b>E080363SF</b>	Posteriore SX	<b>1000</b>	<b>120</b>	

\* N.B. Il montante ad innesto totalmente inox è fornito con la sede e l'innesto in FERRO.  
 Per la sede e l'innesto inox chiedere la differenza al momento dell'ordine



S.P. 231 (Ex S.S. 98) Km. 79+850 - 70026 MODUGNO (BA)  
 http://www.cmvisrl.com - email: info@cmvisrl.com  
 Tel.: 080 - 5358899 - Fax: 080 - 5358909  
 P.IVA: 05329520729

**MONTANTI**

**MONTANTE ROVESCIBILE  
 RIBALTABILE SPESSORE mm 41**

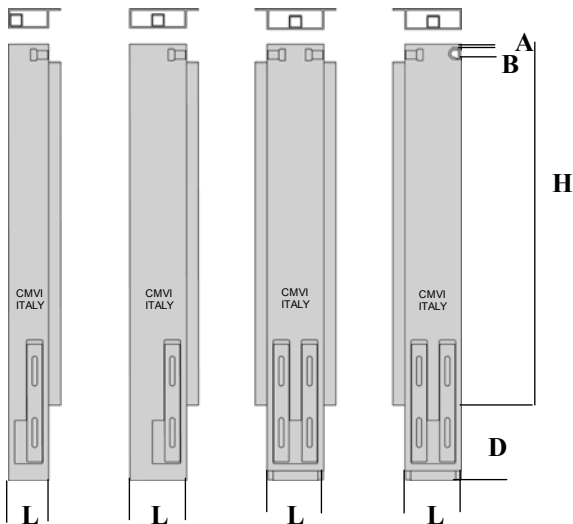

**Caratteristiche Tecniche**

H.	A	B	D		
400	13	50	140		
500	13	50	140		

FERRO	INOX 304 PARZIALE	INOX 304 TOTALE	INOX 304 P. FIORET.	INOX 304 T. FIORET.	DESCRIZIONE	H.	L.	PESO gr
D010204D	D020204D	D030204D	D020204DF	D030204DF	Anteriore DX	400	85	
D010204S	D020204S	D030204S	D020204SF	D030204SF	Anteriore SX	400	85	
D010205D	D020205D	D030205D	D020205DF	D030205DF	Anteriore DX	400	120	
D010205S	D020205S	D030205S	D020205SF	D030205SF	Anteriore SX	400	120	
D010206	D020206	D030206	D020206F	D030206F	Centrale	400	120	
D010207D	D020207D	D030207D	D020207DF	D030207DF	Posteriore DX	400	120	
D010207S	D020207S	D030207S	D020207SF	D030207SF	Posteriore SX	400	120	

D010208D	D020208D	D030208D	D020208DF	D030208DF	Anteriore DX	500	85	
D010208S	D020208S	D030208S	D020208SF	D030208SF	Anteriore SX	500	85	
D010209D	D020209D	D030209D	D020209DF	D030209DF	Anteriore DX	500	120	
D010209S	D020209S	D030209S	D020209SF	D030209SF	Anteriore SX	500	120	
D010210	D020210	D030210	D020210F	D030210F	Centrale	500	120	
D010211D	D020211D	D030211D	D020211DF	D030211DF	Posteriore DX	500	120	
D010211S	D020211S	D030211S	D020211SF	D030211SF	Posteriore SX	500	120	





S.P. 231 (Ex S.S. 98) Km. 79+850 - 70026 MODUGNO (BA)  
 http://www.cmvisrl.com - email: info@cmvisrl.com  
 Tel.: 080 - 5358899 - Fax: 080 - 5358909  
 P.IVA: 05329520729

**MONTANTI**

**MONTANTE ROVESCIBILE  
 RIBALTABILE SPESSORE mm 41**

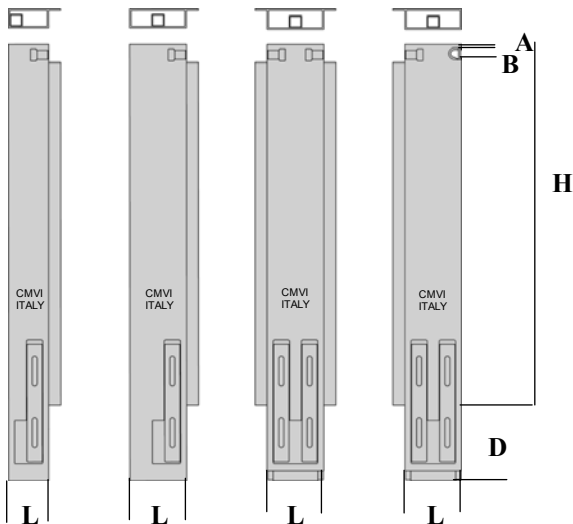

**Caratteristiche Tecniche**

H.	A	B	D		
600	13	30	140		
700	13	30	140		

FERRO	INOX 304 PARZIALE	INOX 304 TOTALE	INOX 304 P. FIORET.	INOX 304 T. FIORET.	DESCRIZIONE	H.	L.	PESO gr
D010212D	D020212D	D030212D	D020212DF	D030212DF	Anteriore DX	600	85	
D010212S	D020212S	D030212S	D020212SF	D030212SF	Anteriore SX	600	85	
D010213D	D020213D	D030213D	D020213DF	D030213DF	Anteriore DX	600	120	
D010213S	D020213S	D030213S	D020213SF	D030213SF	Anteriore SX	600	120	
D010214	D020214	D030214	D020214F	D030214F	Centrale	600	120	
D010215D	D020215D	D030215D	D020215DF	D030215DF	Posteriore DX	600	120	
D010215S	D020215S	D030215S	D020215SF	D030215SF	Posteriore SX	600	120	

D010216D	D020216D	D030216D	D020216DF	D030216DF	Anteriore DX	700	85	
D010216S	D020216S	D030216S	D020216SF	D030216SF	Anteriore SX	700	85	
D010217D	D020217D	D030217D	D020217DF	D030217DF	Anteriore DX	700	120	
D010217S	D020217S	D030217S	D020217SF	D030217SF	Anteriore SX	700	120	
D010218	D020218	D030218	D020218F	D030218F	Centrale	700	120	
D010219D	D020219D	D030219D	D020219DF	D030219DF	Posteriore DX	700	120	
D010219S	D020219S	D030219S	D020219SF	D030219SF	Posteriore SX	700	120	



S.P. 231 (Ex S.S. 98) Km. 79+850 - 70026 MODUGNO (BA)  
 http://www.cmvisrl.com - email: info@cmvisrl.com  
 Tel.: 080 - 5358899 - Fax: 080 - 5358909  
 P.IVA: 05329520729

**MONTANTI**

**MONTANTE ROVESCIBILE  
 RIBALTABILE SPESSORE mm 41**

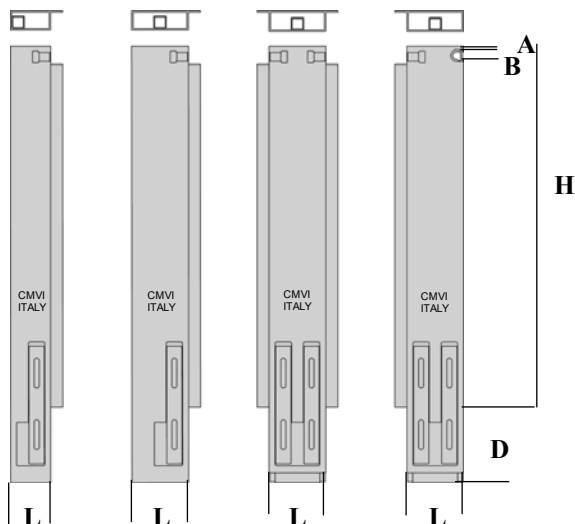

**Caratteristiche Tecniche**

H.	A	B	D		
800	13	30	140		
900	13	30	140		

FERRO	INOX 304 PARZIALE	INOX 304 TOTALE	INOX 304 P. FIORET.	INOX 304 T. FIORET.	DESCRIZIONE	H.	L.	PESO gr
D010220D	D020220D	D030220D	D020220DF	D030220DF	Anteriore DX	800	85	
D010220S	D020220S	D030220S	D020220SF	D030220SF	Anteriore SX	800	85	
D010221D	D020221D	D030221D	D020221DF	D030221DF	Anteriore DX	800	120	
D010221S	D020221S	D030221S	D020221SF	D030221SF	Anteriore SX	800	120	
D010222	D020222	D030222	D020222F	D030222F	Centrale	800	120	
D010223D	D020223D	D030223D	D020223DF	D030223DF	Posteriore DX	800	120	
D010223S	D020223S	D030223S	D020223SF	D030223SF	Posteriore SX	800	120	

D010224D	D020224D	D030224D	D020224DF	D030224DF	Anteriore DX	900	85	
D010224S	D020224S	D030224S	D020224SF	D030224SF	Anteriore SX	900	85	
D010225D	D020225D	D030225D	D020225DF	D030225DF	Anteriore DX	900	120	
D010225S	D020225S	D030225S	D020225SF	D030225SF	Anteriore SX	900	120	
D010226	D020226	D030226	D020226F	D030226F	Centrale	900	120	
D010227D	D020227D	D030227D	D020227DF	D030227DF	Posteriore DX	900	120	
D010227S	D020227S	D030227S	D020227SF	D030227SF	Posteriore SX	900	120	



S.P. 231 (Ex S.S. 98) Km. 79+850 - 70026 MODUGNO (BA)  
 http://www.cmvisrl.com - email: info@cmvisrl.com  
 Tel.: 080 - 5358899 - Fax: 080 - 5358909  
 P.IVA: 05329520729

MONTANTI

MONTANTE ROVESCIBILE  
 RIBALTABILE **SPESSORE mm 41**

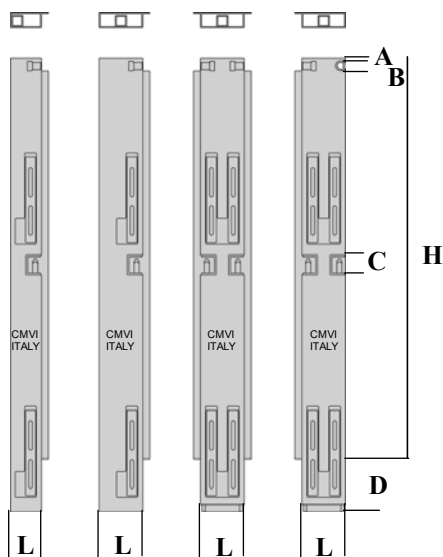

4 LEVE - 2 CHIUSURE

Caratteristiche Tecniche

H.	A	B	D		
1000	13	30	140		
1100	13	30	140		

FERRO	INOX 304 PARZIALE	INOX 304 TOTALE	INOX 304 P. FIORET.	INOX 304 T. FIORET.	DESCRIZIONE	H.	L.	PESO gr
D010228D	D020228D	D030228D	D020228DF	D030228DF	Anteriore DX	1000	85	
D010228S	D020228S	D030228S	D020228SF	D030228SF	Anteriore SX	1000	85	
D010229D	D020229D	D030229D	D020229DF	D030229DF	Anteriore DX	1000	120	
D010229S	D020229S	D030229S	D020229SF	D030229SF	Anteriore SX	1000	120	
D010230	D020230	D030230	D020230F	D030230F	Centrale	1000	120	
D010231D	D020231D	D030231D	D020231DF	D030231DF	Posteriore DX	1000	120	
D010231S	D020231S	D030231S	D020231SF	D030231SF	Posteriore SX	1000	120	

D010232D	D020232D	D030232D	D020232DF	D030232DF	Anteriore DX	1100	85	
D010232S	D020232S	D030232S	D020232SF	D030232SF	Anteriore SX	1100	85	
D010233D	D020233D	D030233D	D020233DF	D030233DF	Anteriore DX	1100	120	
D010233S	D020233S	D030233S	D020233SF	D030233SF	Anteriore SX	1100	120	
D010234	D020234	D030234	D020234F	D030234F	Centrale	1100	120	
D010235D	D020235D	D030235D	D020235DF	D030235DF	Posteriore DX	1100	120	
D010235S	D020235S	D030235S	D020235SF	D030235SF	Posteriore SX	1100	120	



S.P. 231 (Ex S.S. 98) Km. 79+850 - 70026 MODUGNO (BA)  
 http://www.cmvisrl.com - email: info@cmvisrl.com  
 Tel.: 080 - 5358899 - Fax: 080 - 5358909  
 P.IVA: 05329520729

MONTANTI

MONTANTE ROVESCIBILE  
 RIBALTABILE **SPESSORE mm 41**

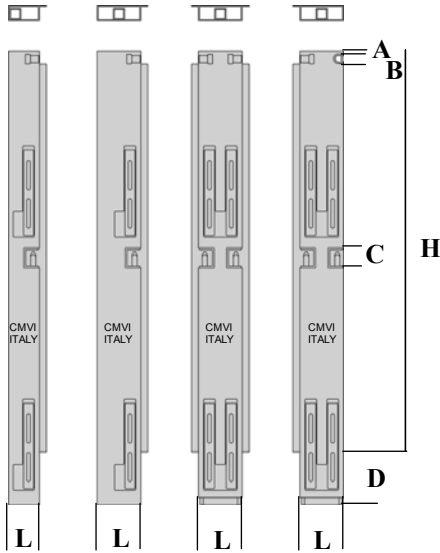

4 LEVE - 2 CHIUSURE

Caratteristiche Tecniche

H.	A	B	C	D	E
1200	13	30	140		

FERRO	INOX 304 PARZIALE	INOX 304 TOTALE	INOX 304 P. FIORET.	INOX 304 T. FIORET.	DESCRIZIONE	H.	L.	PESO gr
<b>D010236D</b>	<b>D020236D</b>	<b>D030236D</b>	<b>D020236DF</b>	<b>D030236DF</b>	Anteriore DX	1200	85	
<b>D010236S</b>	<b>D020236S</b>	<b>D030236S</b>	<b>D020236SF</b>	<b>D030236SF</b>	Anteriore SX	1200	85	
<b>D010237D</b>	<b>D020237D</b>	<b>D030237D</b>	<b>D020237DF</b>	<b>D030237DF</b>	Anteriore DX	1200	120	
<b>D010237S</b>	<b>D020237S</b>	<b>D030237S</b>	<b>D020237SF</b>	<b>D030237SF</b>	Anteriore SX	1200	120	
<b>D010238</b>	<b>D020238</b>	<b>D030238</b>	<b>D020238F</b>	<b>D030238F</b>	Centrale	1200	120	
<b>D010239D</b>	<b>D020239D</b>	<b>D030239D</b>	<b>D020239DF</b>	<b>D030239DF</b>	Posteriore DX	1200	120	
<b>D010239S</b>	<b>D020239S</b>	<b>D030239S</b>	<b>D020239SF</b>	<b>D030239SF</b>	Posteriore SX	1200	120	



S.P. 231 (Ex S.S. 98) Km. 79+850 - 70026 MODUGNO (BA)  
 http://www.cmvisrl.com - email: info@cmvisrl.com  
 Tel.: 080 - 5358899 - Fax: 080 - 5358909  
 P.IVA: 05329520729

**MONTANTI**

## MONTANTE SFILABILE RIBALTABILE **SPESSORE mm 41**

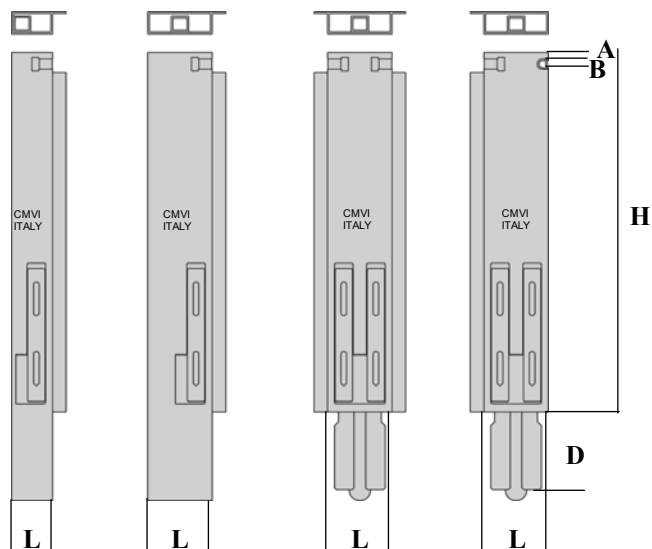

### Caratteristiche Tecniche

H.	A	B	D		
400	13	30	140		
500	13	30	140		

FERRO	INOX 304 PARZIALE	INOX 304* TOTALE	INOX 304 P. FIORET.	INOX 304 T. FIORET.				
CODICE	CODICE	CODICE	CODICE	CODICE	DESCRIZIONE	H.	L.	PESO gr
D040204D	D060204D	D070204D	D060204DF	D070204DF	Anteriore DX	400	85	
D040204S	D060204S	D070204S	D060204SF	D070204SF	Anteriore SX	400	85	
D040205D	D060205D	D070205D	D060205DF	D070205DF	Anteriore DX	400	120	
D040205S	D060205S	D070205S	D060205SF	D070205SF	Anteriore SX	400	120	
D040206	D060206	D070206	D060206F	D070206F	Centrale	400	120	
D040207D	D060207D	D070207D	D060207DF	D070207DF	Posteriore DX	400	120	
D040207S	D060207S	D070207S	D060207SF	D070207SF	Posteriore SX	400	120	

D040208D	D060208D	D070208D	D060208DF	D070208DF	Anteriore DX	500	85	
D040208S	D060208S	D070208S	D060208SF	D070208SF	Anteriore SX	500	85	
D040209D	D060209D	D070209D	D060209DF	D070209DF	Anteriore DX	500	120	
D040209S	D060209S	D070209S	D060209SF	D070209SF	Anteriore SX	500	120	
D040210	D060210	D070210	D060210F	D070210F	Centrale	500	120	
D040211D	D060211D	D070211D	D060211DF	D070211DF	Posteriore DX	500	120	
D040211S	D060211S	D070211S	D060211SF	D070211SF	Posteriore SX	500	120	

\* N.B. Il montante ad innesto totalmente inox è fornito con la sede e l'innesto in FERRO.  
 Per la sede e l'innesto inox chiedere la differenza al momento dell'ordine



S.P. 231 (Ex S.S. 98) Km. 79+850 - 70026 MODUGNO (BA)  
 http://www.cmvisrl.com - email: info@cmvisrl.com  
 Tel.: 080 - 5358899 - Fax: 080 - 5358909  
 P.IVA: 05329520729

**MONTANTI**

**MONTANTE SFILABILE  
 RIBALTABILE SPESSORE mm 41**

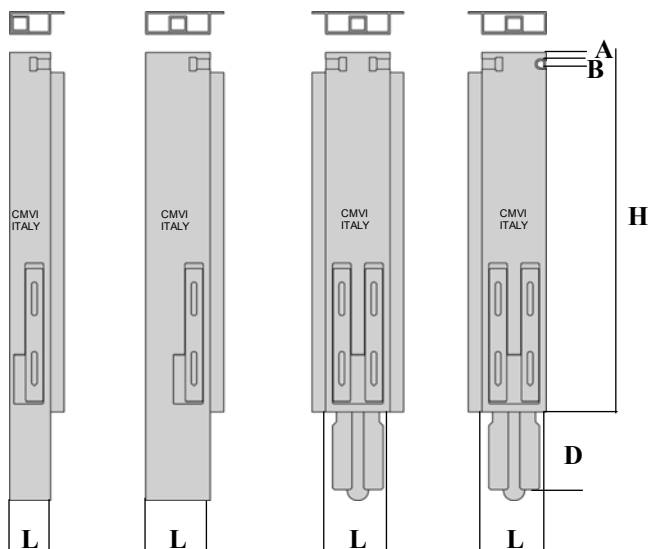

**Caratteristiche Tecniche**

H.	A	B	D		
600	13	30	140		
700	13	30	140		

FERRO	INOX 304 PARZIALE	INOX 304* TOTALE	INOX 304 P. FIORET.	INOX 304 T. FIORET.	DESCRIZIONE	H.	L.	PESO gr
D040212D	D060212D	D070212D	D060212DF	D070212DF	Anteriore DX	600	85	
D040212S	D060212S	D070212S	D060212SF	D070212SF	Anteriore SX	600	85	
D040213D	D060213D	D070213D	D060213DF	D070213DF	Anteriore DX	600	120	
D040213S	D060213S	D070213S	D060213SF	D070213SF	Anteriore SX	600	120	
D040214	D060214	D070214	D060214F	D070214F	Centrale	600	120	
D040215D	D060215D	D070215D	D060215DF	D070215DF	Posteriore DX	600	120	
D040215S	D060215S	D070215S	D060215SF	D070215SF	Posteriore SX	600	120	

D040216D	D060216D	D070216D	D060216DF	D070216DF	Anteriore DX	700	85	
D040216S	D060216S	D070216S	D060216SF	D070216SF	Anteriore SX	700	85	
D040217D	D060217D	D070217D	D060217DF	D070217DF	Anteriore DX	700	120	
D040217S	D060217S	D070217S	D060217SF	D070217SF	Anteriore SX	700	120	
D040218	D060218	D070218	D060218F	D070218F	Centrale	700	120	
D040219D	D060219D	D070219D	D060219DF	D070219DF	Posteriore DX	700	120	
D040219S	D060219S	D070219S	D060219SF	D070219SF	Posteriore SX	700	120	

\* N.B. Il montante ad innesto totalmente inox è fornito con la sede e l'innesto in FERRO.  
 Per la sede e l'innesto inox chiedere la differenza al momento dell'ordine



S.P. 231 (Ex S.S. 98) Km. 79+850 - 70026 MODUGNO (BA)  
 http://www.cmvisrl.com - email: info@cmvisrl.com  
 Tel.: 080 - 5358899 - Fax: 080 - 5358909  
 P.IVA: 05329520729

**MONTANTI**

**MONTANTE SFILABILE  
 RIBALTABILE SPESSORE mm 41**

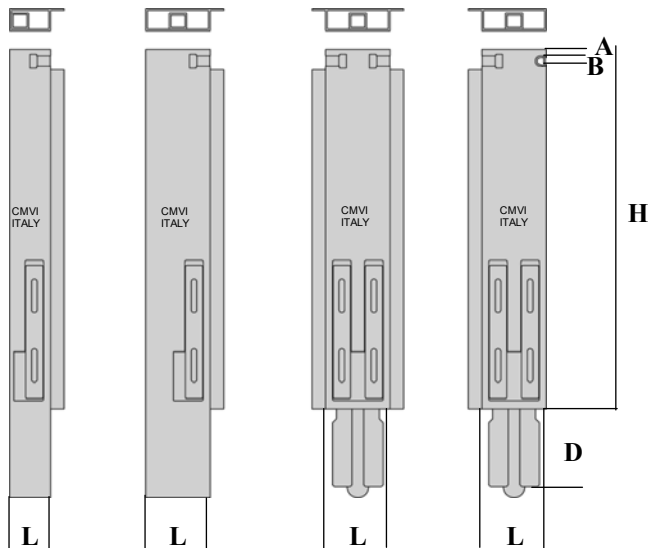

**Caratteristiche Tecniche**

H.	A	B	D		
800	13	30	140		
900	13	30	140		

FERRO	INOX 304 PARZIALE	INOX 304* TOTALE	INOX 304 P. FIORET.	INOX 304 T. FIORET.				
CODICE	CODICE	CODICE	CODICE	CODICE	DESCRIZIONE	H.	L.	PESO gr
D040220D	D060220D	D070220D	D060220DF	D070220DF	Anteriore DX	800	85	
D040220S	D060220S	D070220S	D060220SF	D070220SF	Anteriore SX	800	85	
D040221D	D060221D	D070221D	D060221DF	D070221DF	Anteriore DX	800	120	
D040221S	D060221S	D070221S	D060221SF	D070221SF	Anteriore SX	800	120	
D040222	D060222	D070222	D060222F	D070222F	Centrale	800	120	
D040223D	D060223D	D070223D	D060223DF	D070223DF	Posteriore DX	800	120	
D040223S	D060223S	D070223S	D060223SF	D070223SF	Posteriore SX	800	120	

D040224D	D060224D	D070224D	D060224DF	D070224DF	Anteriore DX	900	85	
D040224S	D060224S	D070224S	D060224SF	D070224SF	Anteriore SX	900	85	
D040225D	D060225D	D070225D	D060225DF	D070225DF	Anteriore DX	900	120	
D040225S	D060225S	D070225S	D060225SF	D070225SF	Anteriore SX	900	120	
D040226	D060226	D070226	D060226F	D070226F	Centrale	900	120	
D040227D	D060227D	D070227D	D060227DF	D070227DF	Posteriore DX	900	120	
D040227S	D060227S	D070227S	D060227SF	D070227SF	Posteriore SX	900	120	

\* N.B. Il montante ad innesto totalmente inox è fornito con la sede e l'innesto in FERRO.  
 Per la sede e l'innesto inox chiedere la differenza al momento dell'ordine



S.P. 231 (Ex S.S. 98) Km. 79+850 - 70026 MODUGNO (BA)  
 http://www.cmvisrl.com - email: info@cmvisrl.com  
 Tel.: 080 - 5358899 - Fax: 080 - 5358909  
 P.IVA: 05329520729

**MONTANTI**

**MONTANTE SFILABILE  
 RIBALTABILE SPESSORE mm 41**

4 LEVE - 2 CHIUSURE

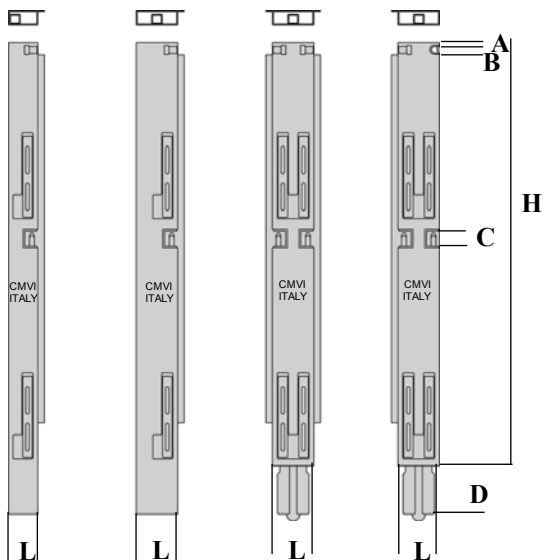

**Caratteristiche Tecniche**

H.	A	B	C	D	
1000	13	30	55	140	
1100	13	30	55	140	

FERRO	INOX 304 PARZIALE	INOX 304* TOTALE	INOX 304 P. FIORET.	INOX 304 T. FIORET.				
CODICE	CODICE	CODICE	CODICE	CODICE	DESCRIZIONE	H.	L.	PESO gr
D040228D	D060228D	D070228D	D060228DF	D070228DF	Anteriore DX	1000	85	
D040228S	D060228S	D070228S	D060228SF	D070228SF	Anteriore SX	1000	85	
D040229D	D060229D	D070229D	D060229DF	D070229DF	Anteriore DX	1000	120	
D040229S	D060229S	D070229S	D060229SF	D070229SF	Anteriore SX	1000	120	
D040230	D060230	D070230	D060230F	D070230F	Centrale	1000	120	
D040231D	D060231D	D070231D	D060231DF	D070231DF	Posteriore DX	1000	120	
D040231S	D060231S	D070231S	D060231SF	D070231SF	Posteriore SX	1000	120	

D040232D	D060232D	D070232D	D060232DF	D070232DF	Anteriore DX	1100	85	
D040232S	D060232S	D070232S	D060232SF	D070232SF	Anteriore SX	1100	85	
D040233D	D060233D	D070233D	D060233DF	D070233DF	Anteriore DX	1100	120	
D040233S	D060233S	D070233S	D060233SF	D070233SF	Anteriore SX	1100	120	
D040234	D060234	D070234	D060234F	D070234F	Centrale	1100	120	
D040235D	D060235D	D070235D	D060235DF	D070235DF	Posteriore DX	1100	120	
D040235S	D060235S	D070235S	D060235SF	D070235SF	Posteriore SX	1100	120	

\* N.B. Il montante ad innesto totalmente inox è fornito con la sede e l'innesto in FERRO.  
 Per la sede e l'innesto inox chiedere la differenza al momento dell'ordine





S.P. 231 (Ex S.S. 98) Km. 79+850 - 70026 MODUGNO (BA)  
 http://www.cmvisrl.com - email: info@cmvisrl.com  
 Tel.: 080 - 5358899 - Fax: 080 - 5358909  
 P.IVA: 05329520729

**MONTANTI**

**MONTANTE SFILABILE  
 RIBALTABILE SPESSORE mm 41**

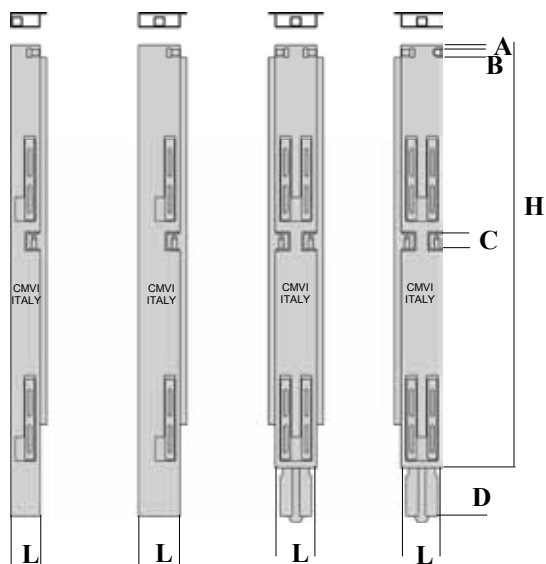

4 LEVE - 2 CHIUSURE

**Caratteristiche Tecniche**

H.	A	B	C	D	
1200	13	30	55	140	

FERRO	INOX 304 PARZIALE	INOX 304* TOTALE	INOX 304 P. FIORET.	INOX 304 T. FIORET.	DESCRIZIONE	H.	L.	PESO gr
D040236D	D060236D	D070236D	D060236DF	D070236DF	Anteriore DX	1200	85	
D040236S	D060236S	D070236S	D060236SF	D070236SF	Anteriore SX	1200	85	
D040237D	D060237D	D070237D	D060237DF	D070237DF	Anteriore DX	1200	120	
D040237S	D060237S	D070237S	D060237SF	D070237SF	Anteriore SX	1200	120	
D040238	D060238	D070238	D060238F	D070238F	Centrale	1200	120	
D040239D	D060239D	D070239D	D060239DF	D070239DF	Posteriore DX	1200	120	
D040239S	D060239S	D070239S	D060239SF	D070239SF	Posteriore SX	1200	120	



\* N.B. Il montante ad innesto totalmente inox è fornito con la sede e l'innesto in FERRO.  
 Per la sede e l'innesto inox chiedere la differenza al momento dell'ordine



S.P. 231 (Ex S.S. 98) Km. 79+850 - 70026 MODUGNO (BA)  
<http://www.cmvisrl.com> - email: [info@cmvisrl.com](mailto:info@cmvisrl.com)  
 Tel.: 080 - 5358899 - Fax: 080 - 5358909  
 P.IVA: 05329520729

**MONTANTI**

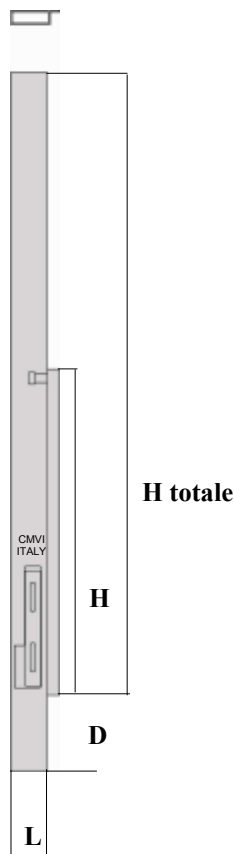
**ANTERIORE ALTO A SALDARE**  
**SPESSORE mm 41**



FERRO	P.INOX							
CODICE				H TOTALE	DESCRIZIONE	H.	L.	PESO gr
D080203D	D080303D			1600	Anteriore DX	400	85	
D080203S	D080303S			1600	Anteriore SX	400	85	
D080204D	D080304D			1800	Anteriore DX	500	85	
D080204S	D080304S			1800	Anteriore SX	500	85	
D080205D	D080305D			1800	Anteriore DX	600	85	
D080205S	D080305S			1800	Anteriore SX	600	85	
D080206D	D080306D			1800	Anteriore DX	700	85	
D080206S	D080306S			1800	Anteriore SX	700	85	
D080207D	D080307D			1800	Anteriore DX	800	85	
D080207S	D080307S			1800	Anteriore SX	800	85	



S.P. 231 (Ex S.S. 98) Km. 79+850 - 70026 MODUGNO (BA)  
<http://www.cmvisrl.com> - email: [info@cmvisrl.com](mailto:info@cmvisrl.com)  
 Tel.: 080 - 5358899 - Fax: 080 - 5358909  
 P.IVA: 05329520729

**MONTANTI**

**MONTANTE ANTERIORE LARGO SFILABILE CON  
 INNESTO SPESSORE mm 41**



**Caratteristiche Tecniche**

A	B	D			
12	32	140			

FERRO	INOX 304 PARZIALE	INOX 304* TOTALE	INOX 304 P. FIORET.	INOX 304 T. FIORET.	DESCRIZIONE	H.	L.	
<b>D040270D</b>	<b>D060240D</b>	<b>D070240D</b>	<b>D060240DF</b>	<b>D070240DF</b>	Anteriore DX	<b>400</b>	<b>120</b>	
<b>D040270S</b>	<b>D060240S</b>	<b>D070240S</b>	<b>D060240SF</b>	<b>D070240SF</b>	Anteriore SX	<b>400</b>	<b>120</b>	
<b>D040271D</b>	<b>D060241D</b>	<b>D070241D</b>	<b>D060241DF</b>	<b>D070241DF</b>	Anteriore DX	<b>500</b>	<b>120</b>	
<b>D040271S</b>	<b>D060241S</b>	<b>D070241S</b>	<b>D060241SF</b>	<b>D070241SF</b>	Anteriore SX	<b>500</b>	<b>120</b>	
<b>D040272D</b>	<b>D060242D</b>	<b>D070242D</b>	<b>D060242DF</b>	<b>D070242DF</b>	Anteriore DX	<b>600</b>	<b>120</b>	
<b>D040272S</b>	<b>D060242S</b>	<b>D070242S</b>	<b>D060242SF</b>	<b>D070242SF</b>	Anteriore SX	<b>600</b>	<b>120</b>	
<b>D040273D</b>	<b>D060243D</b>	<b>D070243D</b>	<b>D060243DF</b>	<b>D070243DF</b>	Anteriore DX	<b>700</b>	<b>120</b>	
<b>D040273S</b>	<b>D060243S</b>	<b>D070243S</b>	<b>D060243SF</b>	<b>D070243SF</b>	Anteriore SX	<b>700</b>	<b>120</b>	
<b>D040274D</b>	<b>D060244D</b>	<b>D070244D</b>	<b>D060244DF</b>	<b>D070244DF</b>	Anteriore DX	<b>800</b>	<b>120</b>	
<b>D040274S</b>	<b>D060244S</b>	<b>D070244S</b>	<b>D060244SF</b>	<b>D070244SF</b>	Anteriore SX	<b>800</b>	<b>120</b>	
<b>D040275D</b>	<b>D060245D</b>	<b>D070245D</b>	<b>D060245DF</b>	<b>D070245DF</b>	Anteriore DX	<b>900</b>	<b>120</b>	
<b>D040275S</b>	<b>D060245S</b>	<b>D070245S</b>	<b>D060245SF</b>	<b>D070245SF</b>	Anteriore SX	<b>900</b>	<b>120</b>	
<b>D040276D</b>	<b>D060246D</b>	<b>D070246D</b>	<b>D060246DF</b>	<b>D070246DF</b>	Anteriore DX	<b>1000</b>	<b>120</b>	
<b>D040276S</b>	<b>D060246S</b>	<b>D070246S</b>	<b>D060246SF</b>	<b>D070246SF</b>	Anteriore SX	<b>1000</b>	<b>120</b>	
<b>D040277D</b>	<b>D060247D</b>	<b>D070247D</b>	<b>D060247DF</b>	<b>D070247DF</b>	Anteriore DX	<b>1100</b>	<b>120</b>	
<b>D040277S</b>	<b>D060247S</b>	<b>D070247S</b>	<b>D060247SF</b>	<b>D070247SF</b>	Anteriore SX	<b>1100</b>	<b>120</b>	
<b>D040278D</b>	<b>D060248D</b>	<b>D070248D</b>	<b>D060248DF</b>	<b>D070248DF</b>	Anteriore DX	<b>1200</b>	<b>120</b>	
<b>D040278S</b>	<b>D060248S</b>	<b>D070248S</b>	<b>D060248SF</b>	<b>D070248SF</b>	Anteriore SX	<b>1200</b>	<b>120</b>	

\* N.B. Il montante ad innesto totalmente inox è fornito con la sede e l'innesto in FERRO.  
 Per la sede e l'innesto inox chiedere la differenza al momento dell'ordine



S.P. 231 (Ex S.S. 98) Km. 79+850 - 70026 MODUGNO (BA)  
 http://www.cmvisrl.com - email: info@cmvisrl.com  
 Tel.: 080 - 5358899 - Fax: 080 - 5358909  
 P.IVA: 05329520729

**MONTANTI**

**MONTANTE ROVESCIBILE SFILABILE  
 RIBALTABILE SPESSORE mm 41**

**PARI SOPRA**

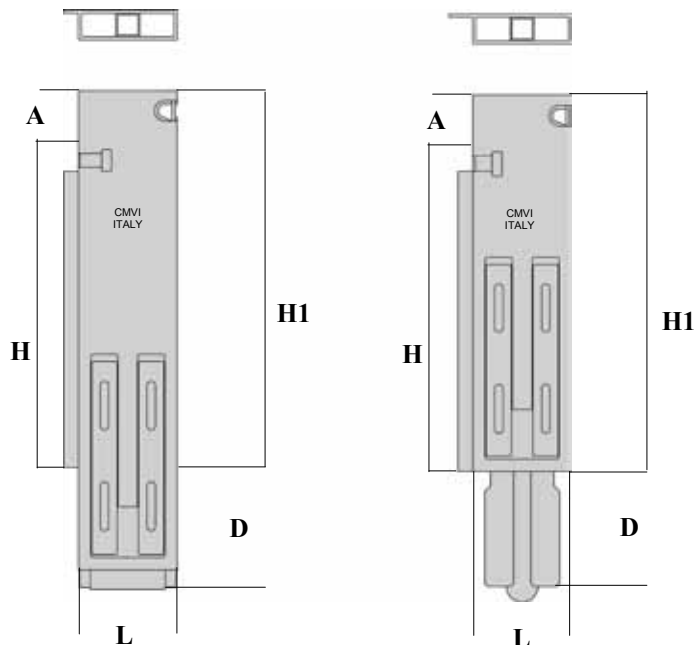

**Caratteristiche Tecniche**

A	B	D			
100		140			
100		140			

FERRO	INOX 304 PARZIALE	INOX 304 TOTALE	INOX 304 P. FIORET.	INOX 304 T. FIORET.	DESCRIZIONE	H/H1	L.	PESO gr
D011207D	D021207D	D031207D	D021207DF	D031207DF	POST. R. R.	400/500	120	
D011207S	D021207S	D031207S	D021207SF	D031207SF	POST. R. R.	400/500	120	
D011211D	D021211D	D031211D	D021211DF	D031211DF	POST. R. R.	500/600	120	
D011211S	D021211S	D031211S	D021211SF	D031211SF	POST. R. R.	500/600	120	
D011215D	D021215D	D031215D	D021215DF	D031215DF	POST. R. R.	600/700	120	
D011215S	D021215S	D031215S	D021215SF	D031215SF	POST. R. R.	600/700	120	
D011219D	D021219D	D031219D	D021219DF	D031219DF	POST. R. R.	700/800	120	
D011219S	D021219S	D031219S	D021219SF	D031219SF	POST. R. R.	700/800	120	

D041207D	D061207D	D071207D	D061207DF	D071207DF	POST. SFIL.	400/500	120	
D041207S	D061207S	D071207S	D061207SF	D071207SF	POST. SFIL.	400/500	120	
D041211D	D061211D	D071211D	D061211DF	D071211DF	POST. SFIL.	500/600	120	
D041211S	D061211S	D071211S	D061211SF	D071211SF	POST. SFIL.	500/600	120	
D041215D	D061215D	D071215D	D061215DF	D071215DF	POST. SFIL.	600/700	120	
D041215S	D061215S	D071215S	D061215SF	D071215SF	POST. SFIL.	600/700	120	
D041219D	D061219D	D071219D	D061219DF	D071219DF	POST. SFIL.	700/800	120	
D041219S	D061219S	D071219S	D061219SF	D071219SF	POST. SFIL.	700/800	120	

\* N.B. Il montante ad innesto totalmente inox è fornito con la sede e l'innesto in FERRO.  
 Per la sede e l'innesto inox chiedere la differenza al momento dell'ordine



S.P. 231 (Ex S.S. 98) Km. 79+850 - 70026 MODUGNO (BA)  
 http://www.cmvisrl.com - email: info@cmvisrl.com  
 Tel.: 080 - 5358899 - Fax: 080 - 5358909  
 P.IVA: 05329520729

**MONTANTI**

**MONTANTE ROVESCIBILE SFILABILE  
 RIBALTABILE SPESSORE mm 41**

**SMUSSATI**

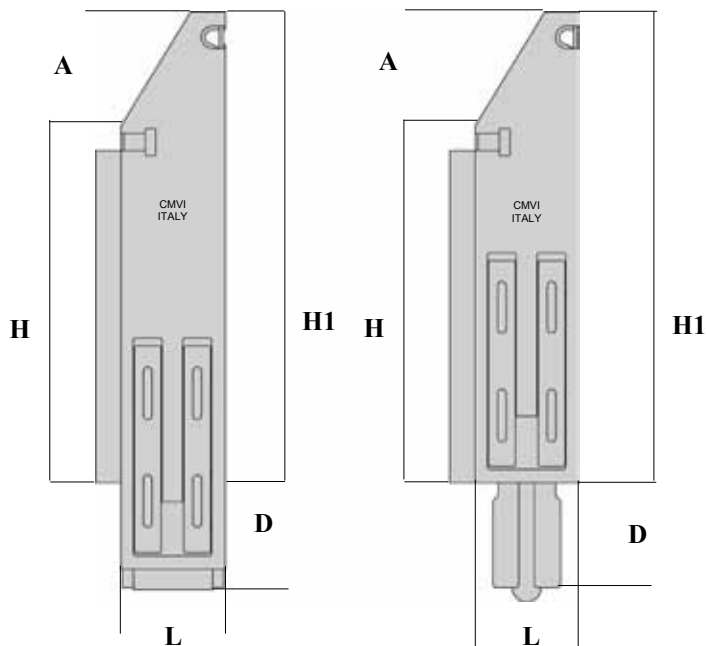

**Caratteristiche Tecniche**

A	B	D			
100		140			
100		140			

FERRO	INOX 304 PARZIALE	INOX 304 TOTALE	INOX 304 P. FIORET.	INOX 304 T. FIORET.	DESCRIZIONE	H/H1	L.	PESO gr
D012207D	D022207D	D032207D	D022207DF	D032207DF	POST. R. R.	400/500	120	
D012207S	D022207S	D032207S	D022207SF	D032207SF	POST. R. R.	400/500	120	
D012211D	D022211D	D032211D	D022211DF	D032211DF	POST. R. R.	500/600	120	
D012211S	D022211S	D032211S	D022211SF	D032211SF	POST. R. R.	500/600	120	
D012215D	D022215D	D032215D	D022215DF	D032215DF	POST. R. R.	600/700	120	
D012215S	D022215S	D032215S	D022215SF	D032215SF	POST. R. R.	600/700	120	
D012219D	D022219D	D032219D	D022219DF	D032219DF	POST. R. R.	700/800	120	
D012219S	D022219S	D032219S	D022219SF	D032219SF	POST. R. R.	700/800	120	

D042207D	D062207D	D072207D	D062207DF	D072207DF	POST. SFIL.	400/500	120	
D042207S	D062207S	D072207S	D062207SF	D072207SF	POST. SFIL.	400/500	120	
D042211D	D062211D	D072211D	D062211DF	D072211DF	POST. SFIL.	500/600	120	
D042211S	D062211S	D072211S	D062211SF	D072211SF	POST. SFIL.	500/600	120	
D042215D	D062215D	D072215D	D062215DF	D072215DF	POST. SFIL.	600/700	120	
D042215S	D062215S	D072215S	D062215SF	D072215SF	POST. SFIL.	600/700	120	
D042219D	D062219D	D072219D	D062219DF	D072219DF	POST. SFIL.	700/800	120	
D042219S	D062219S	D072219S	D062219SF	D072219SF	POST. SFIL.	700/800	120	

\* N.B. Il montante ad innesto totalmente inox è fornito con la sede e l'innesto in FERRO.  
 Per la sede e l'innesto inox chiedere la differenza al momento dell'ordine

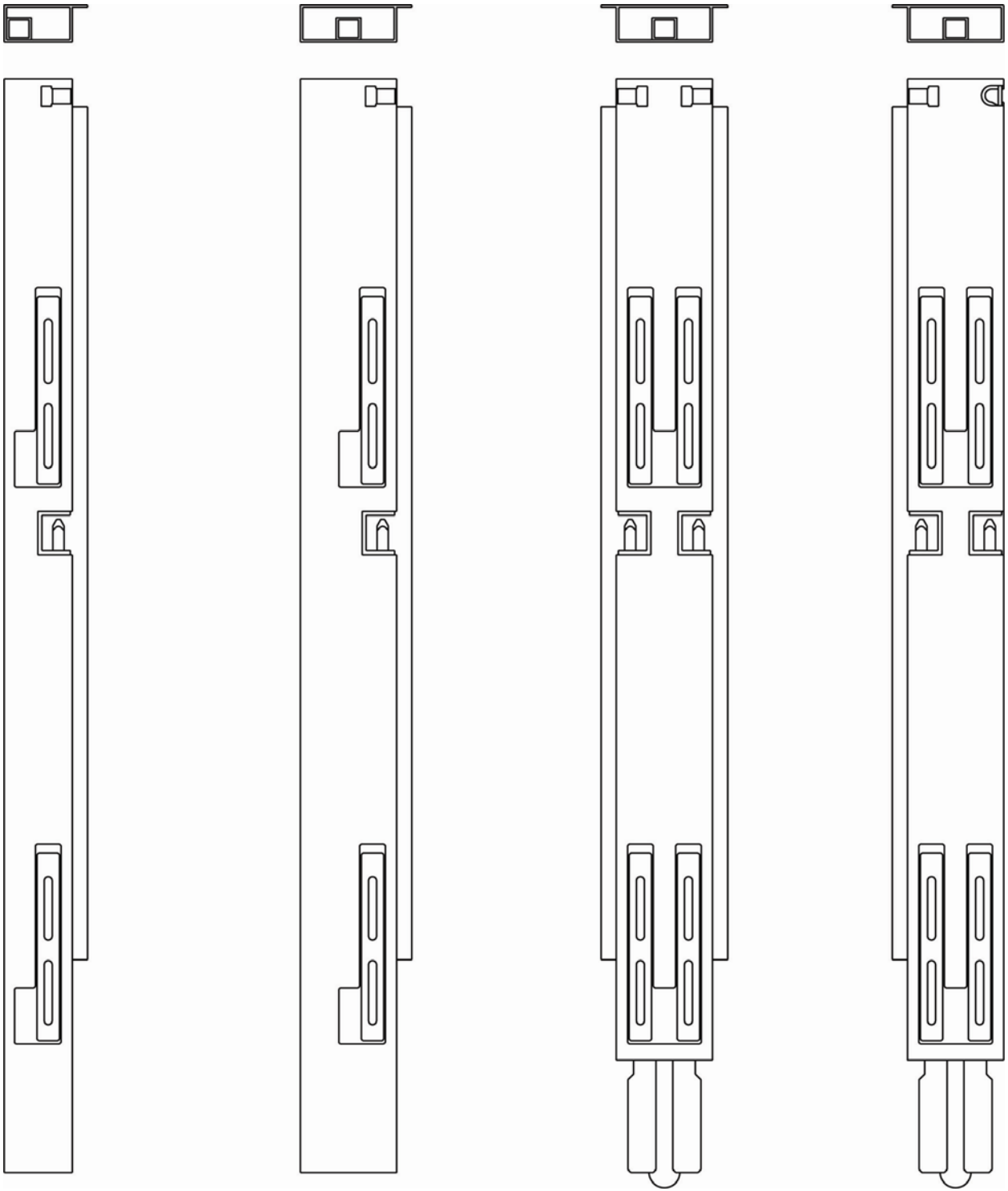

MONTANTI SERIE CMVI SPESSORE mm. 46



S.P. 231 (Ex S.S. 98) Km. 79+850 - 70026 MODUGNO (BA)  
<http://www.cmvisrl.com> - email: [info@cmvisrl.com](mailto:info@cmvisrl.com)  
 Tel.: 080 - 5358899 - Fax: 080 - 5358909  
 P.IVA: 05329520729

**MONTANTI**

## MONTANTE SFILABILE RIBALTABILE SPESSORE mm 46

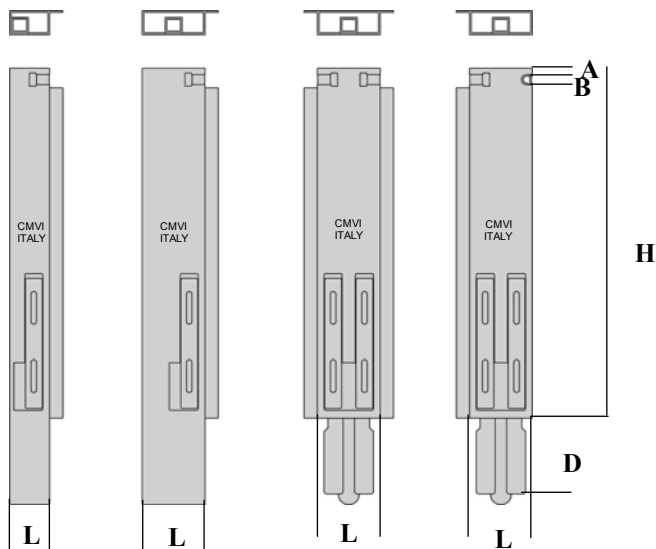

### Caratteristiche Tecniche

H.	A	B	C	D	E

FERRO					FERRO				
CODICE	DESCRIZIONE	H.	L.	PESO gr	CODICE	DESCRIZIONE	H.	L.	PESO gr
<b>D050250D</b>	Anteriore DX	<b>400</b>	<b>90</b>		<b>D050258D</b>	Anteriore DX	<b>600</b>	<b>90</b>	
<b>D050250S</b>	Anteriore SX	<b>400</b>	<b>90</b>		<b>D050258S</b>	Anteriore SX	<b>600</b>	<b>90</b>	
<b>D050251D</b>	Anteriore DX	<b>400</b>	<b>120</b>		<b>D050259D</b>	Anteriore DX	<b>600</b>	<b>120</b>	
<b>D050251S</b>	Anteriore SX	<b>400</b>	<b>120</b>		<b>D050259S</b>	Anteriore SX	<b>600</b>	<b>120</b>	
<b>D050252</b>	Centrale	<b>400</b>	<b>120</b>		<b>D050260</b>	Centrale	<b>600</b>	<b>120</b>	
<b>D050253D</b>	Posteriore DX	<b>400</b>	<b>120</b>		<b>D050261D</b>	Posteriore DX	<b>600</b>	<b>120</b>	
<b>D050253S</b>	Posteriore SX	<b>400</b>	<b>120</b>		<b>D050261S</b>	Posteriore SX	<b>600</b>	<b>120</b>	

<b>D050254D</b>	Anteriore DX	<b>500</b>	<b>90</b>		<b>D050262D</b>	Anteriore DX	<b>700</b>	<b>90</b>	
<b>D050254S</b>	Anteriore SX	<b>500</b>	<b>90</b>		<b>D050262S</b>	Anteriore SX	<b>700</b>	<b>90</b>	
<b>D050255D</b>	Anteriore DX	<b>500</b>	<b>120</b>		<b>D050263D</b>	Anteriore DX	<b>700</b>	<b>120</b>	
<b>D050255S</b>	Anteriore SX	<b>500</b>	<b>120</b>		<b>D050263S</b>	Anteriore SX	<b>700</b>	<b>120</b>	
<b>D050256</b>	Centrale	<b>500</b>	<b>120</b>		<b>D050264</b>	Centrale	<b>700</b>	<b>120</b>	
<b>D050257D</b>	Posteriore DX	<b>500</b>	<b>120</b>		<b>D050265D</b>	Posteriore DX	<b>700</b>	<b>120</b>	
<b>D050257S</b>	Posteriore SX	<b>500</b>	<b>120</b>		<b>D050265S</b>	Posteriore SX	<b>700</b>	<b>120</b>	



S.P. 231 (Ex S.S. 98) Km. 79+850 - 70026 MODUGNO (BA)  
<http://www.cmvisrl.com> - email: [info@cmvisrl.com](mailto:info@cmvisrl.com)  
 Tel.: 080 - 5358899 - Fax: 080 - 5358909  
 P.IVA: 05329520729

MONTANTI

## MONTANTE INNESTO RIBALTABILE SPESSORE mm 46

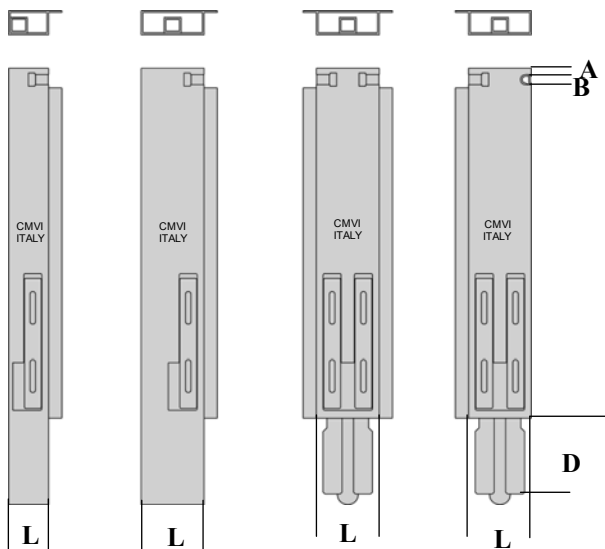

### Caratteristiche Tecniche

H.	A	B	C	D	E

FERRO					FERRO				
CODICE	DESCRIZIONE	H.	L.	PESO gr	CODICE	DESCRIZIONE	H.	L.	PESO gr
D050267D	Anteriore DX	800	90						
D050267S	Anteriore SX	800	90						
D050268D	Anteriore DX	800	120						
D050268S	Anteriore SX	800	120						
D050269	Centrale	800	120						
D050270D	Posteriore DX	800	120						
D050270S	Posteriore SX	800	120						

D050271D	Anteriore DX	900	90						
D050271S	Anteriore SX	900	90						
D050272D	Anteriore DX	900	120						
D050272S	Anteriore SX	900	120						
D050273	Centrale	900	120						
D050274D	Posteriore DX	900	120						
D050274S	Posteriore SX	900	120						





S.P. 231 (Ex S.S. 98) Km. 79+850 - 70026 MODUGNO (BA)  
<http://www.cmvisrl.com> - email: [info@cmvisrl.com](mailto:info@cmvisrl.com)  
 Tel.: 080 - 5358899 - Fax: 080 - 5358909  
 P.IVA: 05329520729

**MONTANTI**

**MONTANTE SFILABILE RIBALTABILE**  
**SPESSORE mm 46**

4 LEVE - 2 CHIUSURE

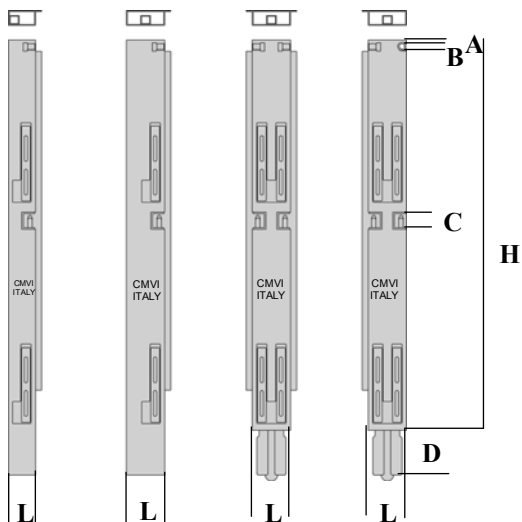

**Caratteristiche Tecniche**

H.	A	B	C	D	E

FERRO					FERRO				
CODICE	DESCRIZIONE	H.	L.	PESO gr	CODICE	DESCRIZIONE	H.	L.	PESO gr
D050275D	Anteriore DX	1000	90		D050283D	Anteriore DX	1200	90	
D050275S	Anteriore SX	1000	90		D050283S	Anteriore SX	1200	90	
D050276D	Anteriore DX	1000	120		D050284D	Anteriore DX	1200	120	
D050276S	Anteriore SX	1000	120		D050284S	Anteriore SX	1200	120	
D050277	Centrale	1000	120		D050285	Centrale	1200	120	
D050278D	Posteriore DX	1000	120		D050286D	Posteriore DX	1200	120	
D050278S	Posteriore SX	1000	120		D050286S	Posteriore SX	1200	120	
D050279D	Anteriore DX	1100	90						
D050279S	Anteriore SX	1100	90						
D050280D	Anteriore DX	1100	120						
D050280S	Anteriore SX	1100	120						
D050281	Centrale	1100	120						
D050282D	Posteriore DX	1100	120						
D050282S	Posteriore SX	1100	120						



S.P. 231 (Ex S.S. 98) Km. 79+850 - 70026 MODUGNO (BA)  
<http://www.cmvisrl.com> - email: [info@cmvisrl.com](mailto:info@cmvisrl.com)  
 Tel.: 080 - 5358899 - Fax: 080 - 5358909  
 P.IVA: 05329520729

**MONTANTI**

**ANTERIORE ALTO A SALDARE**  
**SPESSORE mm 46**

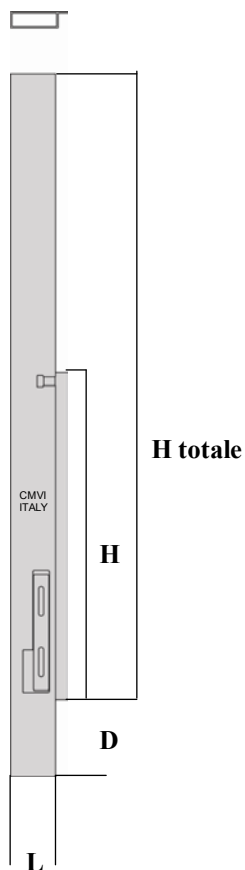

FERRO								
CODICE				H TOTALE	DESCRIZIONE	H.	L.	PESO gr
D090203D				1800	Anteriore DX	400	90	
D090203S				1800	Anteriore SX	400	90	
D090204D				1800	Anteriore DX	500	90	
D090204S				1800	Anteriore SX	500	90	
D090205D				1800	Anteriore DX	600	90	
D090205S				1800	Anteriore SX	600	90	
D090206D				1800	Anteriore DX	700	90	
D090206S				1800	Anteriore SX	700	90	
D090207D				1800	Anteriore DX	800	90	
D090207S				1800	Anteriore SX	800	90	



S.P. 231 (Ex S.S. 98) Km. 79+850 - 70026 MODUGNO (BA)  
<http://www.cmvisrl.com> - email: [info@cmvisrl.com](mailto:info@cmvisrl.com)  
 Tel.: 080 - 5358899 - Fax: 080 - 5358909  
 P.IVA: 05329520729

**MONTANTI**

**MONTANTE ANTERIORE LARGO SFILABILE CON  
 INNESTO SPESSORE mm 46**



**Caratteristiche Tecniche**

A	B	D			
12	32	140			
			DESCRIZIONE	H.	L.
			Anteriore DX	400	120
			Anteriore SX	400	120
			Anteriore DX	500	120
			Anteriore SX	500	120
			Anteriore DX	600	120
			Anteriore SX	600	120
			Anteriore DX	700	120
			Anteriore SX	700	120
			Anteriore DX	800	120
			Anteriore SX	800	120
			Anteriore DX	900	120
			Anteriore SX	900	120
			Anteriore DX	1000	120
			Anteriore SX	1000	120
			Anteriore DX	1100	120
			Anteriore SX	1100	120
			Anteriore DX	1200	120
			Anteriore SX	1200	120

FERRO				
CODICE				
D050287				
D050287				
D050288				
D050288				
D050289				
D050289				
D050290				
D050290				
D050291				
D050291				
D050292				
D050292				
D050293				
D050293				
D050294				
D050294				
D050295				
D050295				



S.P. 231 (Ex S.S. 98) Km. 79+850 - 70026 MODUGNO (BA)  
 http://www.cmvisrl.com - email: info@cmvisrl.com  
 Tel.: 080 - 5358899 - Fax: 080 - 5358909  
 P.IVA: 05329520729

**MONTANTI**

**MONTANTE POSTERIORE SFILABILE  
 RIBALTABILE SPESSORE mm 46**

**PARI SOPRA-SMUSSATO**

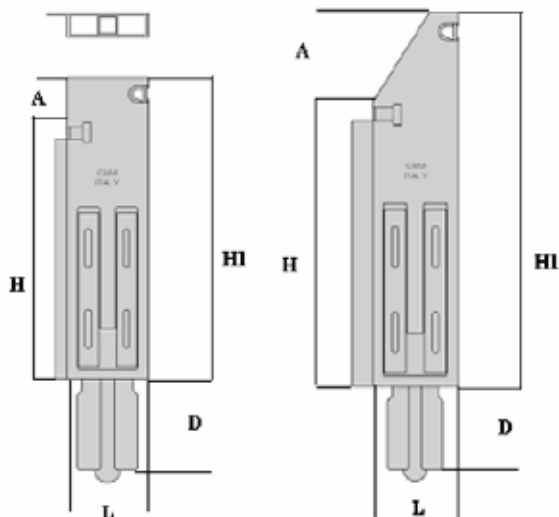

**Caratteristiche Tecniche**

A	B	D			
100		140			
100		140			

FERRO	INOX 304 PARZIALE	INOX 304 TOTALE	INOX 304 P. FIORET.	INOX 304 T. FIORET.	DESCRIZIONE	H/H1	L.	PESO gr
CODICE	CODICE	CODICE	CODICE	CODICE				
					POST. P.S.	400/500	120	
					POST. P.S.	400/500	120	
					POST. P.S.	500/600	120	
					POST. P.S.	500/600	120	
					POST. P.S.	600/700	120	
					POST. P.S.	600/700	120	
					POST. P.S.	700/800	120	
					POST. P.S.	700/800	120	

					POST. SMUSS.	400/500	120	
					POST. SMUSS.	400/500	120	
					POST. SMUSS.	500/600	120	
					POST. SMUSS.	500/600	120	
					POST. SMUSS.	600/700	120	
					POST. SMUSS.	600/700	120	
					POST. SMUSS.	700/800	120	
					POST. SMUSS.	700/800	120	

\* N.B. Il montante ad innesto totalmente inox è fornito con la sede e l'innesto in FERRO.  
 Per la sede e l'innesto inox chiedere la differenza al momento dell'ordine

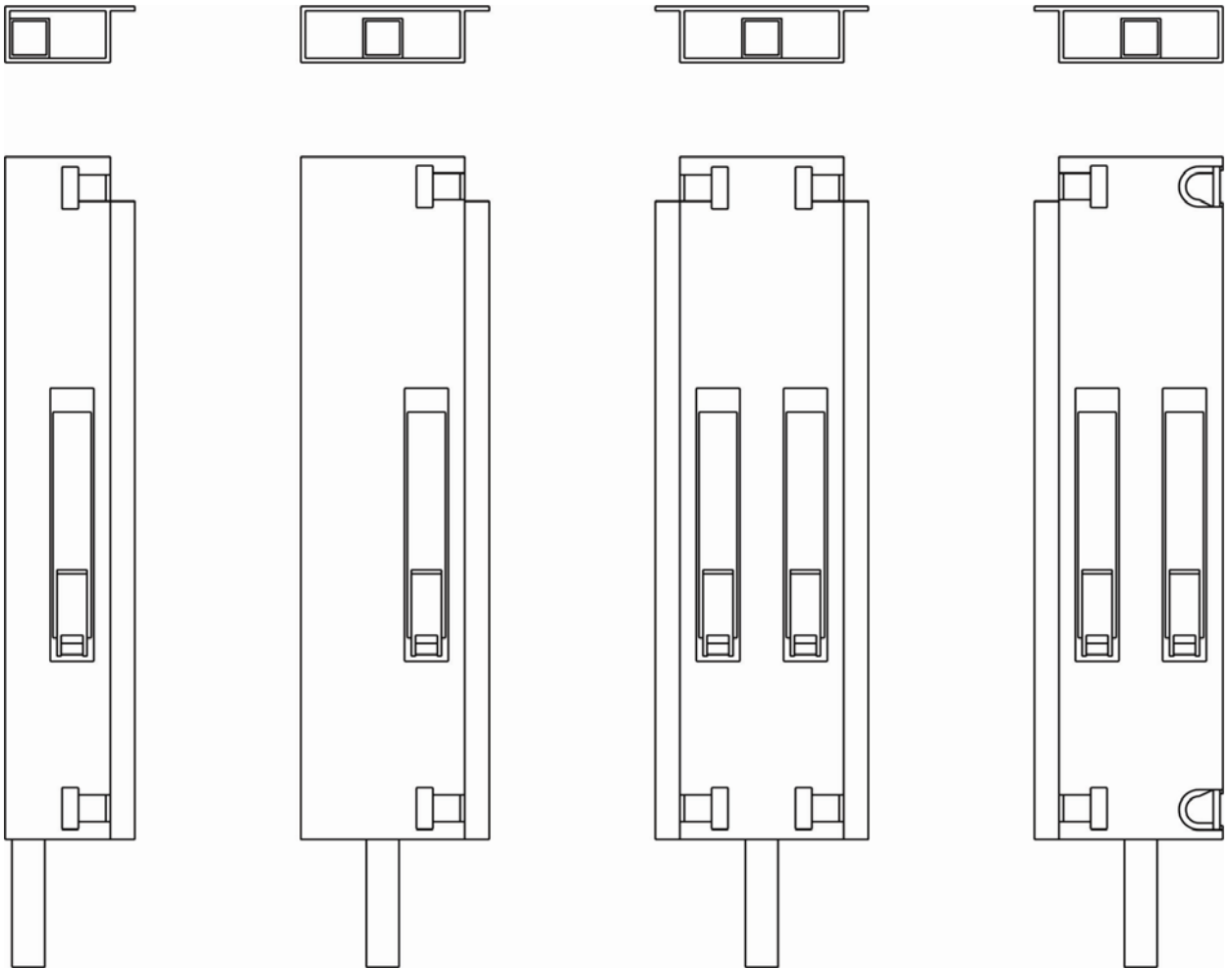

SOVRAMONTANTI SERIE CMVI



S.P. 231 (Ex S.S. 98) Km. 79+850 - 70026 MODUGNO (BA)  
<http://www.cmvisrl.com> - email: [info@cmvisrl.com](mailto:info@cmvisrl.com)  
 Tel.: 080 - 5358899 - Fax: 080 - 5358909  
 P.IVA: 05329520729

SOVRAMONTANTI

## SOVRAMONTANTE TUBOLARE SPESSORE mm 33

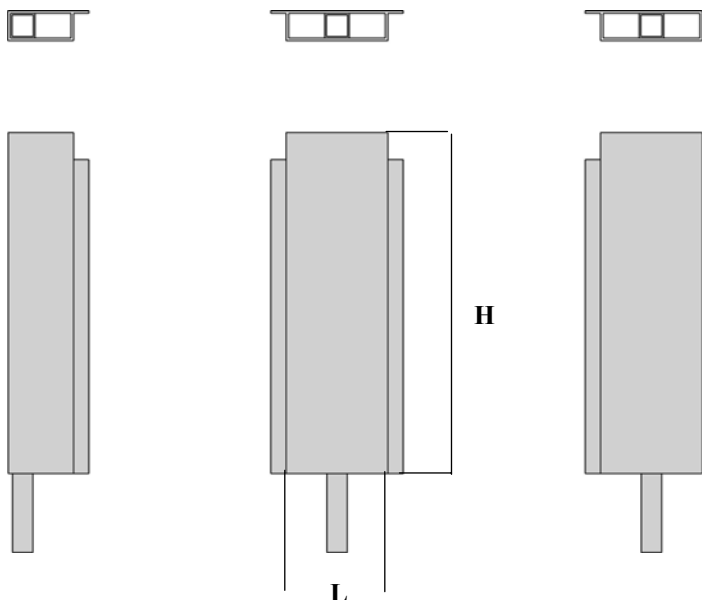

### Caratteristiche Tecniche

			H.			
			400			
			500			
FERRO	INOX 304 TOTALE	INOX 304 T. FIORET.				
CODICE	CODICE	CODICE	DESCRIZIONE	H.	L.	PESO gr
G080410D	G090410D	G090410DF	Anteriore DX	400	85	
G080410S	G090410S	G090410SF	Anteriore SX	400	85	
G080411D	G090411D	G090411DF	Anteriore DX	400	120	
G080411S	G090411S	G090411SF	Anteriore SX	400	120	
G080412	G090412	G090412F	Centrale	400	120	
G080413D	G090413D	G090413DF	Posteriore DX	400	120	
G080413S	G090413S	G090413SF	Posteriore SX	400	120	

G080414D	G090414D	G090414DF	Anteriore DX	500	85	
G080414S	G090414S	G090414SF	Anteriore SX	500	85	
G080415D	G090415D	G090415DF	Anteriore DX	500	120	
G080415S	G090415S	G090415SF	Anteriore SX	500	120	
G080416	G090416	G090416F	Centrale	500	120	
G080417D	G090417D	G090417DF	Posteriore DX	500	120	
G080417S	G090417S	G090417SF	Posteriore SX	500	120	



S.P. 231 (Ex S.S. 98) Km. 79+850 - 70026 MODUGNO (BA)  
<http://www.cmvisrl.com> - email: [info@cmvisrl.com](mailto:info@cmvisrl.com)  
 Tel.: 080 - 5358899 - Fax: 080 - 5358909  
 P.IVA: 05329520729

SOVRAMONTANTI

## SOVRAMONTANTE TUBOLARE SPESSORE mm 33

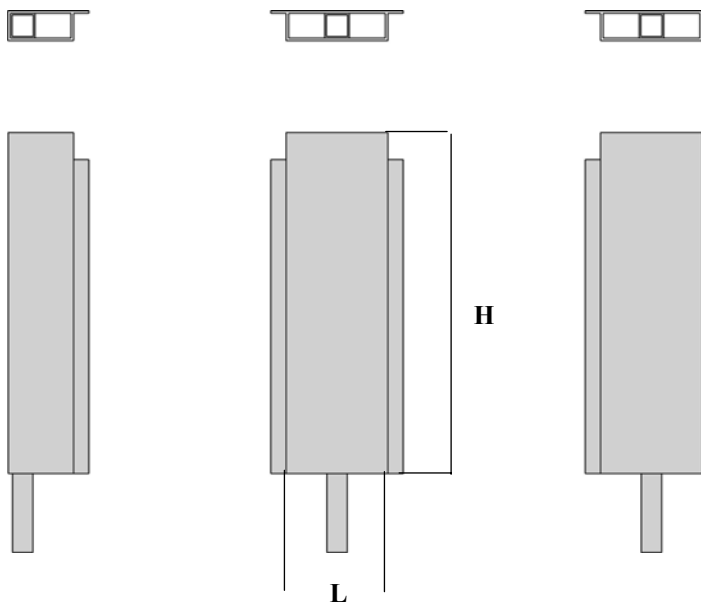

### Caratteristiche Tecniche

			H.			
			600			
			700			
FERRO	INOX 304 TOTALE	INOX 304 T. FIORET.				
CODICE	CODICE	CODICE	DESCRIZIONE	H.	L.	PESO gr
G080418D	G090418D	G090418DF	Anteriore DX	600	85	
G080418S	G090418S	G090418SF	Anteriore SX	600	85	
G080419D	G090419D	G090419DF	Anteriore DX	600	120	
G080419S	G090419S	G090419SF	Anteriore SX	600	120	
G080420	G090420	G090420F	Centrale	600	120	
G080421D	G090421D	G090421DF	Posteriore DX	600	120	
G080421S	G090421S	G090421SF	Posteriore SX	600	120	

G080422D	G090422D	G090422DF	Anteriore DX	700	85	
G080422S	G090422S	G090422SF	Anteriore SX	700	85	
G080423D	G090423D	G090423DF	Anteriore DX	700	120	
G080423S	G090423S	G090423SF	Anteriore SX	700	120	
G080424	G090424	G090424F	Centrale	700	120	
G080425D	G090425D	G090425DF	Posteriore DX	700	120	
G080425S	G090425S	G090425SF	Posteriore SX	700	120	



S.P. 231 (Ex S.S. 98) Km. 79+850 - 70026 MODUGNO (BA)  
<http://www.cmvisrl.com> - email: [info@cmvisrl.com](mailto:info@cmvisrl.com)  
 Tel.: 080 - 5358899 - Fax: 080 - 5358909  
 P.IVA: 05329520729

SOVRAMONTANTI

SOVRAMONTANTE TUBOLARE  
**SPESSORE mm 33**

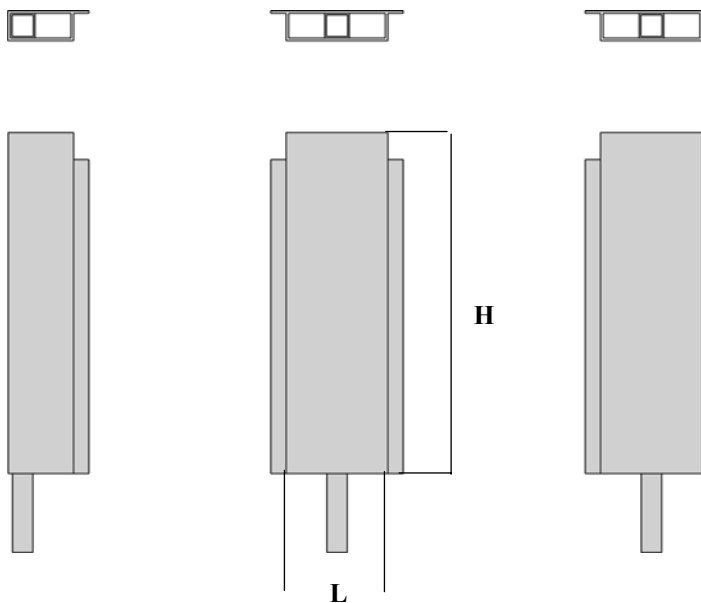

Caratteristiche Tecniche

FERRO	INOX 304 TOTALE	INOX 304 T. FIORET.			H.			
CODICE	CODICE	CODICE			DESCRIZIONE	H.	L.	PESO gr
G080426D	G090426D	G090426DF			Anteriore DX	800	85	
G080426S	G090426S	G090426SF			Anteriore SX	800	85	
G080427D	G090427D	G090427DF			Anteriore DX	800	120	
G080427S	G090427S	G090427SF			Anteriore SX	800	120	
G080428	G090428	G090428F			Centrale	800	120	
G080429D	G090429D	G090429DF			Posteriore DX	800	120	
G080429S	G090429S	G090429SF			Posteriore SX	800	120	







S.P. 231 (Ex S.S. 98) Km. 79+850 - 70026 MODUGNO (BA)  
<http://www.cmvisrl.com> - email: [info@cmvisrl.com](mailto:info@cmvisrl.com)  
 Tel.: 080 - 5358899 - Fax: 080 - 5358909  
 P.IVA: 05329520729

SOVRAMONTANTI

SOVRAMONTANTE A LEVA RIBALTABILE  
**SPESSORE mm 33**

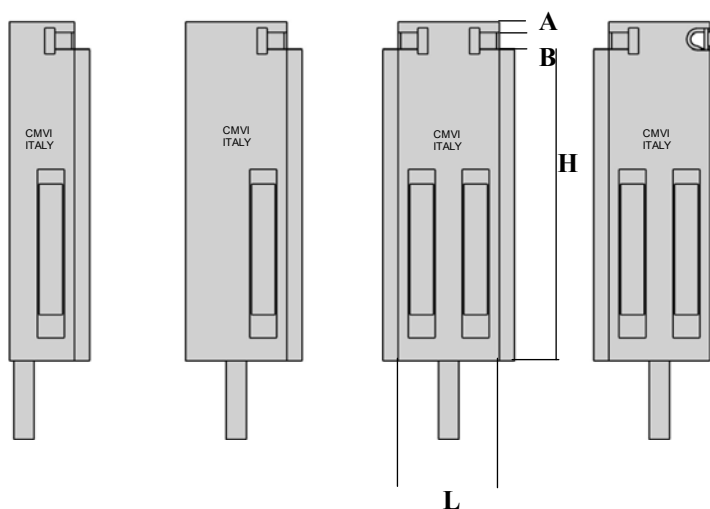

SPECIALE



**Caratteristiche Tecniche**

A	B				
13	30				

FERRO	INOX 304 PARZIALE	INOX 304 TOTALE	INOX 304 P. FIORET.	INOX 304 T. FIORET.	DESCRIZIONE	H.	L.	PESO gr
CODICE	CODICE	CODICE	CODICE	CODICE				
G008350D	G018350D	G028350D	G018350DF	G028350DF	Anteriore DX	380	85	
G008350S	G018350S	G028350S	G018350SF	G028350SF	Anteriore SX	380	85	
G008351D	G018351D	G028351D	G018351DF	G028351DF	Anteriore DX	380	120	
G008351S	G018351S	G028351S	G018351SF	G028351SF	Anteriore SX	380	120	
G008352	G018352	G028352	G018352F	G028352F	Centrale	380	120	
G008353D	G018353D	G028353D	G018353DF	G028353DF	Posteriore DX	380	120	
G008353S	G018353S	G028353S	G018353SF	G028353SF	Posteriore SX	380	120	

G008354D	G018354D	G028354D	G018354DF	G028354DF	Anteriore DX	480	85	
G008354S	G018354S	G028354S	G018354SF	G028354SF	Anteriore SX	480	85	
G008355D	G018355D	G028355D	G018355DF	G028355DF	Anteriore DX	480	120	
G008355S	G018355S	G028355S	G018355SF	G028355SF	Anteriore SX	480	120	
G008356	G018356	G028356	G018356F	G028356F	Centrale	480	120	
G008357D	G018357D	G028357D	G018357DF	G028357DF	Posteriore DX	480	120	
G008357S	G018357S	G028357S	G018357SF	G028357SF	Posteriore SX	480	120	



S.P. 231 (Ex S.S. 98) Km. 79+850 - 70026 MODUGNO (BA)  
<http://www.cmvisrl.com> - email: [info@cmvisrl.com](mailto:info@cmvisrl.com)  
 Tel.: 080 - 5358899 - Fax: 080 - 5358909  
 P.IVA: 05329520729

SOVRAMONTANTI

SOVRAMONTANTE A LEVA RIBALTABILE  
**SPESSORE mm 33**



SPECIALE

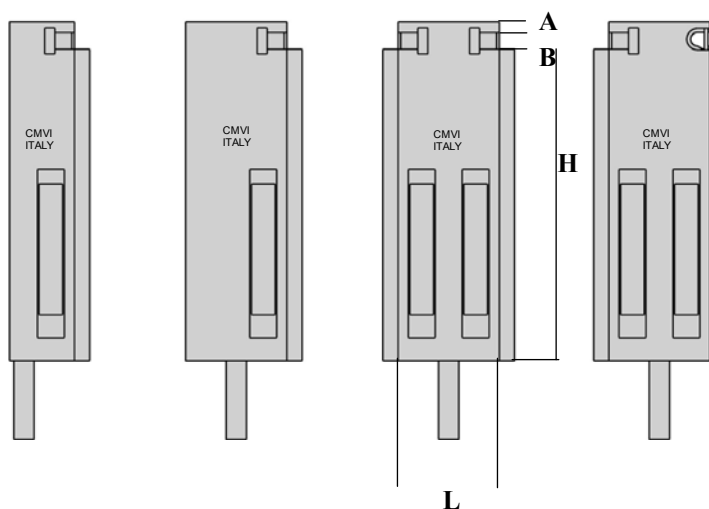

**Caratteristiche Tecniche**

A	B				
13	30				

FERRO	INOX 304 PARZIALE	INOX 304 TOTALE	INOX 304 P. FIORET.	INOX 304 T. FIORET.	DESCRIZIONE	H.	L.	PESO gr
<b>G008358D</b>	<b>G018358D</b>	<b>G028358D</b>	<b>G018358DF</b>	<b>G028358DF</b>	Anteriore DX	<b>580</b>	<b>85</b>	
<b>G008358S</b>	<b>G018358S</b>	<b>G028358S</b>	<b>G018358SF</b>	<b>G028358SF</b>	Anteriore SX	<b>580</b>	<b>85</b>	
<b>G008359D</b>	<b>G018359D</b>	<b>G028359D</b>	<b>G018359DF</b>	<b>G028359DF</b>	Anteriore DX	<b>580</b>	<b>120</b>	
<b>G008359S</b>	<b>G018359S</b>	<b>G028359S</b>	<b>G018359SF</b>	<b>G028359SF</b>	Anteriore SX	<b>580</b>	<b>120</b>	
<b>G008360</b>	<b>G018360</b>	<b>G028360</b>	<b>G018360F</b>	<b>G028360F</b>	Centrale	<b>580</b>	<b>120</b>	
<b>G008361D</b>	<b>G018361D</b>	<b>G028361D</b>	<b>G018361DF</b>	<b>G028361DF</b>	Posteriore DX	<b>580</b>	<b>120</b>	
<b>G008361S</b>	<b>G018361S</b>	<b>G028361S</b>	<b>G018361SF</b>	<b>G028361SF</b>	Posteriore SX	<b>580</b>	<b>120</b>	

<b>G008362D</b>	<b>G018362D</b>	<b>G028362D</b>	<b>G018362DF</b>	<b>G028362DF</b>	Anteriore DX	<b>680</b>	<b>85</b>	
<b>G008362S</b>	<b>G018362S</b>	<b>G028362S</b>	<b>G018362SF</b>	<b>G028362SF</b>	Anteriore SX	<b>680</b>	<b>85</b>	
<b>G008363D</b>	<b>G018363D</b>	<b>G028363D</b>	<b>G018363DF</b>	<b>G028363DF</b>	Anteriore DX	<b>680</b>	<b>120</b>	
<b>G008363S</b>	<b>G018363S</b>	<b>G028363S</b>	<b>G018363SF</b>	<b>G028363SF</b>	Anteriore SX	<b>680</b>	<b>120</b>	
<b>G008364</b>	<b>G018364</b>	<b>G028364</b>	<b>G018364F</b>	<b>G028364F</b>	Centrale	<b>680</b>	<b>120</b>	
<b>G008365D</b>	<b>G018365D</b>	<b>G028365D</b>	<b>G018365DF</b>	<b>G028365DF</b>	Posteriore DX	<b>680</b>	<b>120</b>	
<b>G008365S</b>	<b>G018365S</b>	<b>G028365S</b>	<b>G018365SF</b>	<b>G028365SF</b>	Posteriore SX	<b>680</b>	<b>120</b>	



S.P. 231 (Ex S.S. 98) Km. 79+850 - 70026 MODUGNO (BA)  
<http://www.cmvisrl.com> - email: [info@cmvisrl.com](mailto:info@cmvisrl.com)  
 Tel.: 080 - 5358899 - Fax: 080 - 5358909  
 P.IVA: 05329520729

SOVRAMONTANTI

SOVRAMONTANTE A LEVA RIBALTABILE  
**SPESSORE mm 33**



SPECIALE

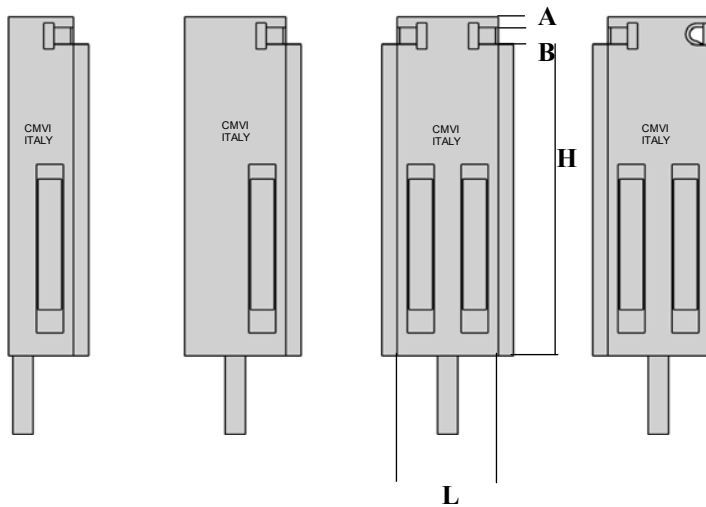

**Caratteristiche Tecniche**

A	B				
13	30				

FERRO	INOX 304 PARZIALE	INOX 304 TOTALE	INOX 304 P. FIORET.	INOX 304 T. FIORET.	DESCRIZIONE	H.	L.	PESO gr
CODICE	CODICE	CODICE	CODICE	CODICE				
G008366D	G018366D	G028366D	G018366DF	G028366DF	Anteriore DX	780	85	
G008366S	G018366S	G028366S	G018366SF	G028366SF	Anteriore SX	780	85	
G008367D	G018367D	G028367D	G018367DF	G028367DF	Anteriore DX	780	120	
G008367S	G018367S	G028367S	G018367SF	G028367SF	Anteriore SX	780	120	
G008368	G018368	G028368	G018368F	G028368F	Centrale	780	120	
G008369D	G018369D	G028369D	G018369DF	G028369DF	Posteriore DX	780	120	
G008369S	G018369S	G028369S	G018369SF	G028369SF	Posteriore SX	780	120	





S.P. 231 (Ex S.S. 98) Km. 79+850 - 70026 MODUGNO (BA)  
<http://www.cmvisrl.com> - email: [info@cmvisrl.com](mailto:info@cmvisrl.com)  
 Tel.: 080 - 5358899 - Fax: 080 - 5358909  
 P.IVA: 05329520729

SOVRAMONTANTI

SOVRAMONTANTE A LEVA RIBALTABILE  
**SPESSORE mm 33**

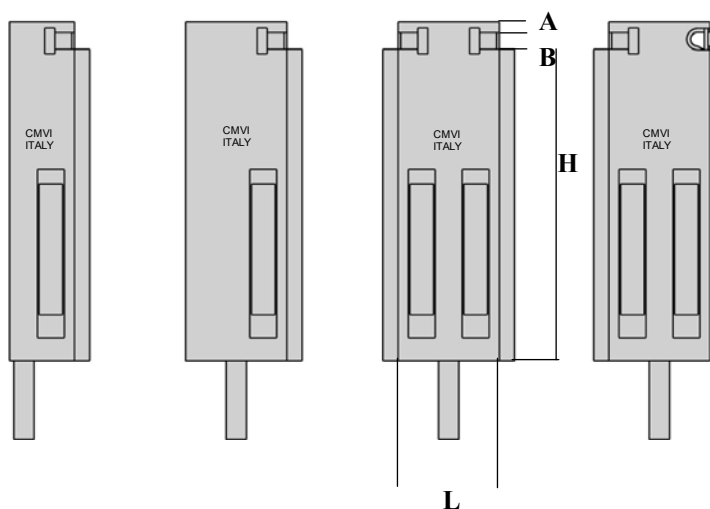

SPECIALE



**Caratteristiche Tecniche**

A	B				
13	30				

FERRO	INOX 304 PARZIALE	INOX 304 TOTALE	INOX 304 P. FIORET.	INOX 304 T. FIORET.	DESCRIZIONE	H.	L.	PESO gr
CODICE	CODICE	CODICE	CODICE	CODICE				
G009350D	G019350D	G029350D	G019350DF	G029350DF	Anteriore DX	390	85	
G009350S	G019350S	G029350S	G019350SF	G029350SF	Anteriore SX	390	85	
G009351D	G019351D	G029351D	G019351DF	G029351DF	Anteriore DX	390	120	
G009351S	G019351S	G029351S	G019351SF	G029351SF	Anteriore SX	390	120	
G009352	G019352	G029352	G019352F	G029352F	Centrale	390	120	
G009353D	G019353D	G029353D	G019353DF	G029353DF	Posteriore DX	390	120	
G009353S	G019353S	G029353S	G019353SF	G029353SF	Posteriore SX	390	120	

G009354D	G019354D	G029354D	G019354DF	G029354DF	Anteriore DX	490	85	
G009354S	G019354S	G029354S	G019354SF	G029354SF	Anteriore SX	490	85	
G009355D	G019355D	G029355D	G019355DF	G029355DF	Anteriore DX	490	120	
G009355S	G019355S	G029355S	G019355SF	G029355SF	Anteriore SX	490	120	
G009356	G019356	G029356	G019356F	G029356F	Centrale	490	120	
G009357D	G019357D	G029357D	G019357DF	G029357DF	Posteriore DX	490	120	
G009357S	G019357S	G029357S	G019357SF	G029357SF	Posteriore SX	490	120	



S.P. 231 (Ex S.S. 98) Km. 79+850 - 70026 MODUGNO (BA)  
<http://www.cmvisrl.com> - email: [info@cmvisrl.com](mailto:info@cmvisrl.com)  
 Tel.: 080 - 5358899 - Fax: 080 - 5358909  
 P.IVA: 05329520729

SOVRAMONTANTI

SOVRAMONTANTE A LEVA RIBALTABILE  
**SPESSORE mm 33**



SPECIALE

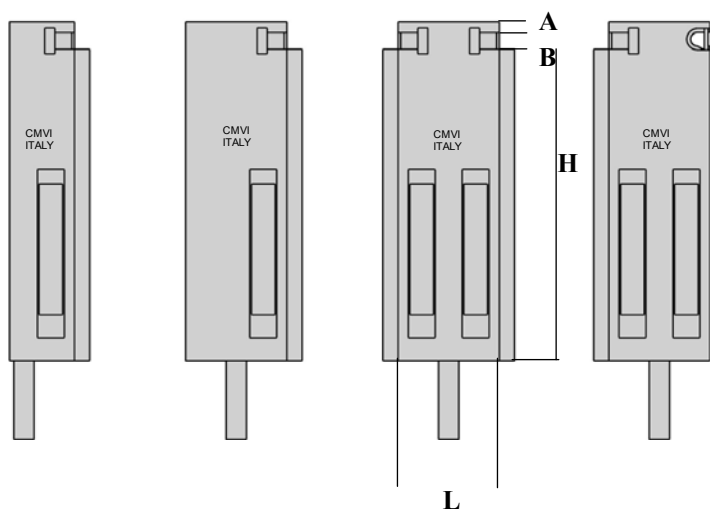

**Caratteristiche Tecniche**

A	B				
13	30				

FERRO	INOX 304 PARZIALE	INOX 304 TOTALE	INOX 304 P. FIORET.	INOX 304 T. FIORET.	DESCRIZIONE	H.	L.	PESO gr
<b>G009358D</b>	<b>G019358D</b>	<b>G029358D</b>	<b>G019358DF</b>	<b>G029358DF</b>	Anteriore DX	<b>590</b>	<b>85</b>	
<b>G009358S</b>	<b>G019358S</b>	<b>G029358S</b>	<b>G019358SF</b>	<b>G029358SF</b>	Anteriore SX	<b>590</b>	<b>85</b>	
<b>G009359D</b>	<b>G019359D</b>	<b>G029359D</b>	<b>G019359DF</b>	<b>G029359DF</b>	Anteriore DX	<b>590</b>	<b>120</b>	
<b>G009359S</b>	<b>G019359S</b>	<b>G029359S</b>	<b>G019359SF</b>	<b>G029359SF</b>	Anteriore SX	<b>590</b>	<b>120</b>	
<b>G009360</b>	<b>G019360</b>	<b>G029360</b>	<b>G019360F</b>	<b>G029360F</b>	Centrale	<b>590</b>	<b>120</b>	
<b>G009361D</b>	<b>G019361D</b>	<b>G029361D</b>	<b>G019361DF</b>	<b>G029361DF</b>	Posteriore DX	<b>590</b>	<b>120</b>	
<b>G009361S</b>	<b>G019361S</b>	<b>G029361S</b>	<b>G019361SF</b>	<b>G029361SF</b>	Posteriore SX	<b>590</b>	<b>120</b>	

<b>G009362D</b>	<b>G019362D</b>	<b>G029362D</b>	<b>G019362DF</b>	<b>G029362DF</b>	Anteriore DX	<b>690</b>	<b>85</b>	
<b>G009362S</b>	<b>G019362S</b>	<b>G029362S</b>	<b>G019362SF</b>	<b>G029362SF</b>	Anteriore SX	<b>690</b>	<b>85</b>	
<b>G009363D</b>	<b>G019363D</b>	<b>G029363D</b>	<b>G019363DF</b>	<b>G029363DF</b>	Anteriore DX	<b>690</b>	<b>120</b>	
<b>G009363S</b>	<b>G019363S</b>	<b>G029363S</b>	<b>G019363SF</b>	<b>G029363SF</b>	Anteriore SX	<b>690</b>	<b>120</b>	
<b>G009364</b>	<b>G019364</b>	<b>G029364</b>	<b>G019364F</b>	<b>G029364F</b>	Centrale	<b>690</b>	<b>120</b>	
<b>G009365D</b>	<b>G019365D</b>	<b>G029365D</b>	<b>G019365DF</b>	<b>G029365DF</b>	Posteriore DX	<b>690</b>	<b>120</b>	
<b>G009365S</b>	<b>G019365S</b>	<b>G029365S</b>	<b>G019365SF</b>	<b>G029365SF</b>	Posteriore SX	<b>690</b>	<b>120</b>	



S.P. 231 (Ex S.S. 98) Km. 79+850 - 70026 MODUGNO (BA)  
<http://www.cmvisrl.com> - email: [info@cmvisrl.com](mailto:info@cmvisrl.com)  
 Tel.: 080 - 5358899 - Fax: 080 - 5358909  
 P.IVA: 05329520729

SOVRAMONTANTI

SOVRAMONTANTE A LEVA RIBALTABILE  
**SPESSORE mm 33**

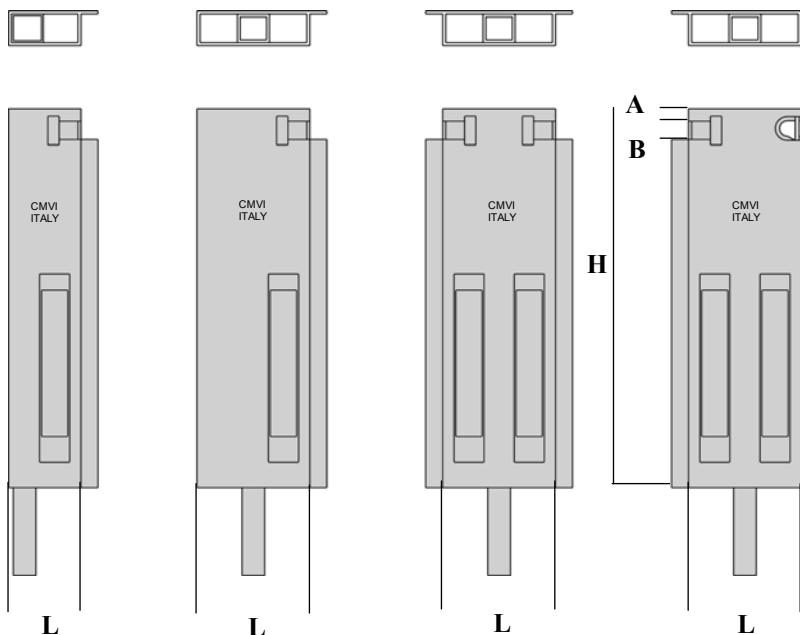

SPECIALE

**Caratteristiche Tecniche**

A	B				
13	30				

FERRO	INOX 304 PARZIALE	INOX 304 TOTALE	INOX 304 P. FIORET.	INOX 304 T. FIORET.	DESCRIZIONE	H.	L.	PESO gr
CODICE	CODICE	CODICE	CODICE	CODICE				
G009366D	G019366D	G029366D	G019366DF	G029366DF	Anteriore DX	790	85	
G009366S	G019366S	G029366S	G019366SF	G029366SF	Anteriore SX	790	85	
G009367D	G019367D	G029367D	G019367DF	G029367DF	Anteriore DX	790	120	
G009367S	G019367S	G029367S	G019367SF	G029367SF	Anteriore SX	790	120	
G009368	G019368	G029368	G019368F	G029368F	Centrale	790	120	
G009369D	G019369D	G029369D	G019369DF	G029369DF	Posteriore DX	790	120	
G009369S	G019369S	G029369S	G019369SF	G029369SF	Posteriore SX	790	120	



S.P. 231 (Ex S.S. 98) Km. 79+850 - 70026 MODUGNO (BA)  
<http://www.cmvisrl.com> - email: [info@cmvisrl.com](mailto:info@cmvisrl.com)  
 Tel.: 080 - 5358899 - Fax: 080 - 5358909  
 P.IVA: 05329520729

SOVRAMONTANTI

SOVRAMONTANTE A LEVA RIBALTABILE  
**SPESSORE mm 33**

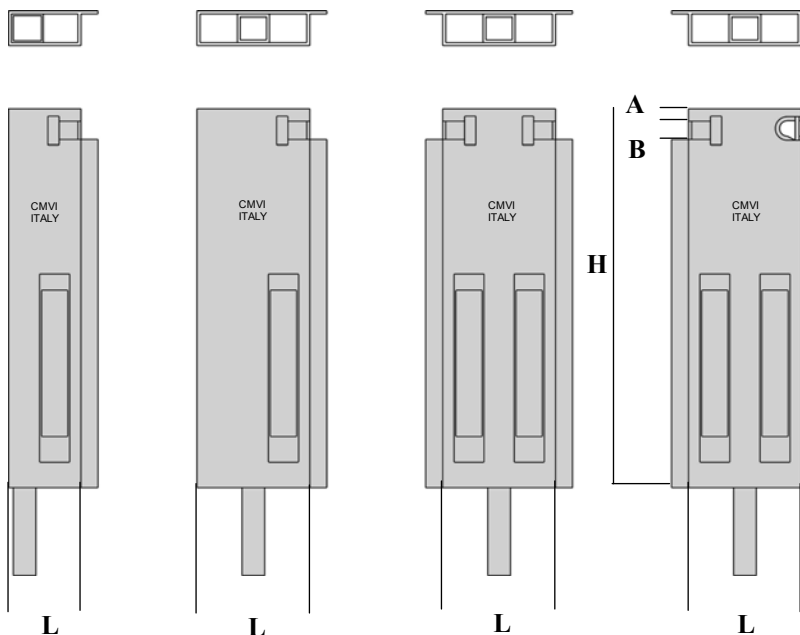

**Caratteristiche Tecniche**

A	B				
13	30				

FERRO	INOX 304 PARZIALE	INOX 304 TOTALE	INOX 304 P. FIORET.	INOX 304 T. FIORET.	DESCRIZIONE	H.	L.	PESO gr
<b>G010350D</b>	<b>G020350D</b>	<b>G030350D</b>	<b>G020350DF</b>	<b>G030350DF</b>	Anteriore DX	<b>400</b>	<b>85</b>	
<b>G010350S</b>	<b>G020350S</b>	<b>G030350S</b>	<b>G020350SF</b>	<b>G030350SF</b>	Anteriore SX	<b>400</b>	<b>85</b>	
<b>G010351D</b>	<b>G020351D</b>	<b>G030351D</b>	<b>G020351DF</b>	<b>G030351DF</b>	Anteriore DX	<b>400</b>	<b>120</b>	
<b>G010351S</b>	<b>G020351S</b>	<b>G030351S</b>	<b>G020351SF</b>	<b>G030351SF</b>	Anteriore SX	<b>400</b>	<b>120</b>	
<b>G010352</b>	<b>G020352</b>	<b>G030352</b>	<b>G020352F</b>	<b>G030352F</b>	Centrale	<b>400</b>	<b>120</b>	
<b>G010353D</b>	<b>G020353D</b>	<b>G030353D</b>	<b>G020353DF</b>	<b>G030353DF</b>	Posteriore DX	<b>400</b>	<b>120</b>	
<b>G010353S</b>	<b>G020353S</b>	<b>G030353S</b>	<b>G020353SF</b>	<b>G030353SF</b>	Posteriore SX	<b>400</b>	<b>120</b>	

<b>G010354D</b>	<b>G020354D</b>	<b>G030354D</b>	<b>G020354DF</b>	<b>G030354DF</b>	Anteriore DX	<b>500</b>	<b>85</b>	
<b>G010354S</b>	<b>G020354S</b>	<b>G030354S</b>	<b>G020354SF</b>	<b>G030354SF</b>	Anteriore SX	<b>500</b>	<b>85</b>	
<b>G010355D</b>	<b>G020355D</b>	<b>G030355D</b>	<b>G020355DF</b>	<b>G030355DF</b>	Anteriore DX	<b>500</b>	<b>120</b>	
<b>G010355S</b>	<b>G020355S</b>	<b>G030355S</b>	<b>G020355SF</b>	<b>G030355SF</b>	Anteriore SX	<b>500</b>	<b>120</b>	
<b>G010356</b>	<b>G020356</b>	<b>G030356</b>	<b>G020356F</b>	<b>G030356F</b>	Centrale	<b>500</b>	<b>120</b>	
<b>G010357D</b>	<b>G020357D</b>	<b>G030357D</b>	<b>G020357DF</b>	<b>G030357DF</b>	Posteriore DX	<b>500</b>	<b>120</b>	
<b>G010357S</b>	<b>G020357S</b>	<b>G030357S</b>	<b>G020357SF</b>	<b>G030357SF</b>	Posteriore SX	<b>500</b>	<b>120</b>	



S.P. 231 (Ex S.S. 98) Km. 79+850 - 70026 MODUGNO (BA)  
<http://www.cmvisrl.com> - email: [info@cmvisrl.com](mailto:info@cmvisrl.com)  
 Tel.: 080 - 5358899 - Fax: 080 - 5358909  
 P.IVA: 05329520729

SOVRAMONTANTI

SOVRAMONTANTE A LEVA RIBALTABILE  
**SPESSORE mm 33**

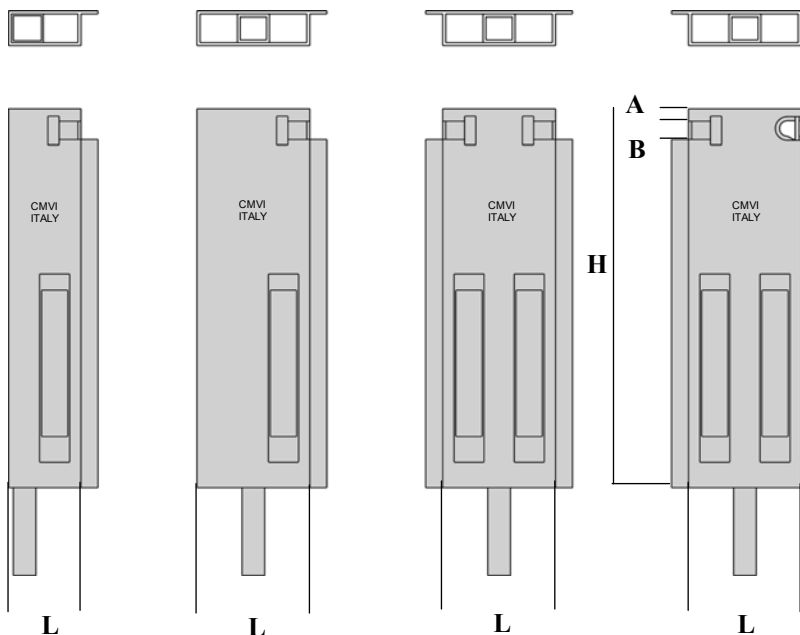

**Caratteristiche Tecniche**

A	B				
13	30				

FERRO	INOX 304 PARZIALE	INOX 304 TOTALE	INOX 304 P. FIORET.	INOX 304 T. FIORET.	DESCRIZIONE	H.	L.	PESO gr
<b>G010358D</b>	<b>G020358D</b>	<b>G030358D</b>	<b>G020358DF</b>	<b>G030358DF</b>	Anteriore DX	<b>600</b>	<b>85</b>	
<b>G010358S</b>	<b>G020358S</b>	<b>G030358S</b>	<b>G020358SF</b>	<b>G030358SF</b>	Anteriore SX	<b>600</b>	<b>85</b>	
<b>G010359D</b>	<b>G020359D</b>	<b>G030359D</b>	<b>G020359DF</b>	<b>G030359DF</b>	Anteriore DX	<b>600</b>	<b>120</b>	
<b>G010359S</b>	<b>G020359S</b>	<b>G030359S</b>	<b>G020359SF</b>	<b>G030359SF</b>	Anteriore SX	<b>600</b>	<b>120</b>	
<b>G010360</b>	<b>G020360</b>	<b>G030360</b>	<b>G020360F</b>	<b>G030360F</b>	Centrale	<b>600</b>	<b>120</b>	
<b>G010361D</b>	<b>G020361D</b>	<b>G030361D</b>	<b>G020361DF</b>	<b>G030361DF</b>	Posteriore DX	<b>600</b>	<b>120</b>	
<b>G010361S</b>	<b>G020361S</b>	<b>G030361S</b>	<b>G020361SF</b>	<b>G030361SF</b>	Posteriore SX	<b>600</b>	<b>120</b>	

<b>G010362D</b>	<b>G020362D</b>	<b>G030362D</b>	<b>G020362DF</b>	<b>G030362DF</b>	Anteriore DX	<b>700</b>	<b>85</b>	
<b>G010362S</b>	<b>G020362S</b>	<b>G030362S</b>	<b>G020362SF</b>	<b>G030362SF</b>	Anteriore SX	<b>700</b>	<b>85</b>	
<b>G010363D</b>	<b>G020363D</b>	<b>G030363D</b>	<b>G020363DF</b>	<b>G030363DF</b>	Anteriore DX	<b>700</b>	<b>120</b>	
<b>G010363S</b>	<b>G020363S</b>	<b>G030363S</b>	<b>G020363SF</b>	<b>G030363SF</b>	Anteriore SX	<b>700</b>	<b>120</b>	
<b>G010364</b>	<b>G020364</b>	<b>G030364</b>	<b>G020364F</b>	<b>G030364F</b>	Centrale	<b>700</b>	<b>120</b>	
<b>G010365D</b>	<b>G020365D</b>	<b>G030365D</b>	<b>G020365DF</b>	<b>G030365DF</b>	Posteriore DX	<b>700</b>	<b>120</b>	
<b>G010365S</b>	<b>G020365S</b>	<b>G030365S</b>	<b>G020365SF</b>	<b>G030365SF</b>	Posteriore SX	<b>700</b>	<b>120</b>	





S.P. 231 (Ex S.S. 98) Km. 79+850 - 70026 MODUGNO (BA)  
<http://www.cmvisrl.com> - email: [info@cmvisrl.com](mailto:info@cmvisrl.com)  
 Tel.: 080 - 5358899 - Fax: 080 - 5358909  
 P.IVA: 05329520729

SOVRAMONTANTI

SOVRAMONTANTE A LEVA RIBALTABILE  
**SPESSORE mm 33**

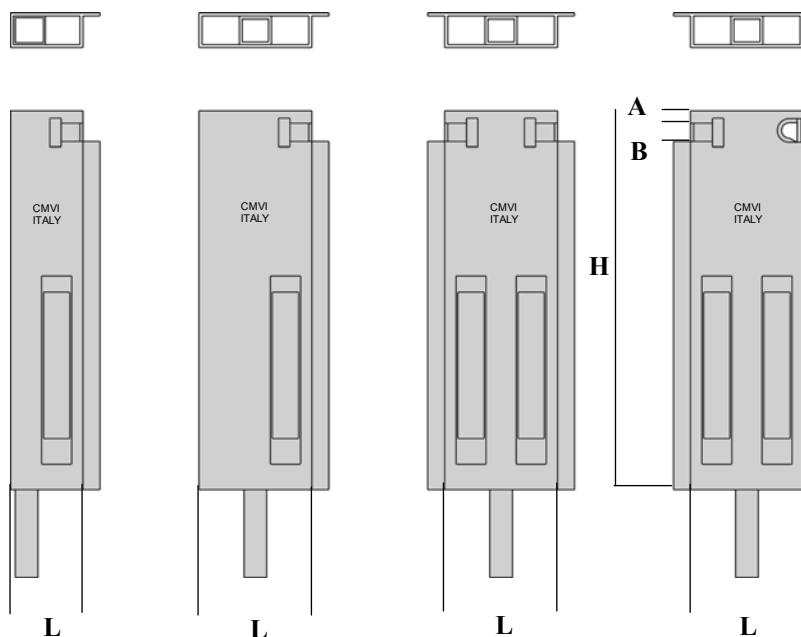

### Caratteristiche Tecniche

A	B				
13	30				

FERRO	INOX 304 PARZIALE	INOX 304 TOTALE	INOX 304 P. FIORET.	INOX 304 T. FIORET.	DESCRIZIONE	H.	L.	PESO gr
<b>G010366D</b>	<b>G020366D</b>	<b>G030366D</b>	<b>G020366DF</b>	<b>G030366DF</b>	Anteriore DX	<b>800</b>	<b>85</b>	
<b>G010366S</b>	<b>G020366S</b>	<b>G030366S</b>	<b>G020366SF</b>	<b>G030366SF</b>	Anteriore SX	<b>800</b>	<b>85</b>	
<b>G010367D</b>	<b>G020367D</b>	<b>G030367D</b>	<b>G020367DF</b>	<b>G030367DF</b>	Anteriore DX	<b>800</b>	<b>120</b>	
<b>G010367S</b>	<b>G020367S</b>	<b>G030367S</b>	<b>G020367SF</b>	<b>G030367SF</b>	Anteriore SX	<b>800</b>	<b>120</b>	
<b>G010368</b>	<b>G020368</b>	<b>G030368</b>	<b>G020368F</b>	<b>G030368F</b>	Centrale	<b>800</b>	<b>120</b>	
<b>G010369D</b>	<b>G020369D</b>	<b>G030369D</b>	<b>G020369DF</b>	<b>G030369DF</b>	Posteriore DX	<b>800</b>	<b>120</b>	
<b>G010369S</b>	<b>G020369S</b>	<b>G030369S</b>	<b>G020369SF</b>	<b>G030369SF</b>	Posteriore SX	<b>800</b>	<b>120</b>	

<b>G010370D</b>	<b>G020370D</b>	<b>G030370D</b>	<b>G020370DF</b>	<b>G030370DF</b>	Anteriore DX	<b>900</b>	<b>85</b>	
<b>G010370S</b>	<b>G020370S</b>	<b>G030370S</b>	<b>G020370SF</b>	<b>G030370SF</b>	Anteriore SX	<b>900</b>	<b>85</b>	
<b>G010371D</b>	<b>G020371D</b>	<b>G030371D</b>	<b>G020371DF</b>	<b>G030371DF</b>	Anteriore DX	<b>900</b>	<b>120</b>	
<b>G010371S</b>	<b>G020371S</b>	<b>G030371S</b>	<b>G020371SF</b>	<b>G030371SF</b>	Anteriore SX	<b>900</b>	<b>120</b>	
<b>G010372</b>	<b>G020372</b>	<b>G030372</b>	<b>G020372F</b>	<b>G030372F</b>	Centrale	<b>900</b>	<b>120</b>	
<b>G010373D</b>	<b>G020373D</b>	<b>G030373D</b>	<b>G020373DF</b>	<b>G030373DF</b>	Posteriore DX	<b>900</b>	<b>120</b>	
<b>G010373S</b>	<b>G020373S</b>	<b>G030373S</b>	<b>G020373SF</b>	<b>G030373SF</b>	Posteriore SX	<b>900</b>	<b>120</b>	



S.P. 231 (Ex S.S. 98) Km. 79+850 - 70026 MODUGNO (BA)  
<http://www.cmvisrl.com> - email: [info@cmvisrl.com](mailto:info@cmvisrl.com)  
 Tel.: 080 - 5358899 - Fax: 080 - 5358909  
 P.IVA: 05329520729

SOVRAMONTANTI

SOVRAMONTANTE A LEVA RIBALTABILE  
**SPESSORE mm 33**

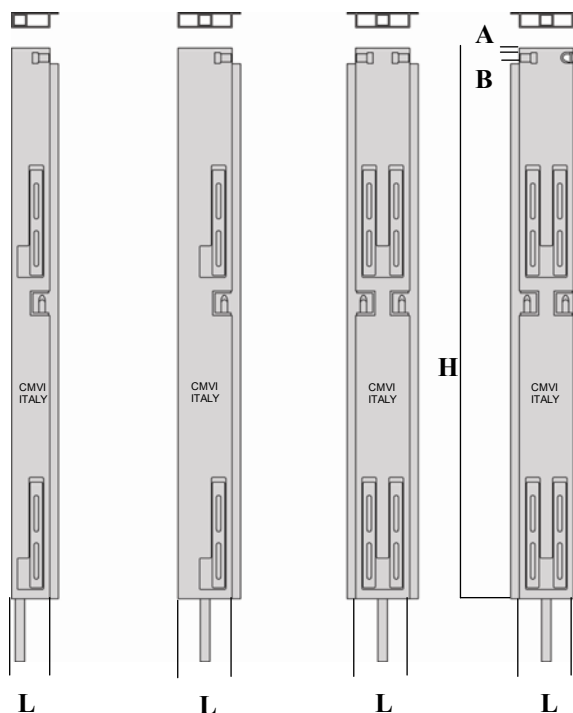

4 LEVE - 2 CHIUSURE

**Caratteristiche Tecniche**

A	B				
13	30				

FERRO	INOX 304 PARZIALE	INOX 304 TOTALE	INOX 304 P. FIORET.	INOX 304 T. FIORET.	DESCRIZIONE	H.	L.	PESO gr
G010374D	G020374D	G030374D	G020374DF	G030374DF	Anteriore DX	1000	85	
G010374S	G020374S	G030374S	G020374SF	G030374SF	Anteriore SX	1000	85	
G010375D	G020375D	G030375D	G020375DF	G030375DF	Anteriore DX	1000	120	
G010375S	G020375S	G030375S	G020375SF	G030375SF	Anteriore SX	1000	120	
G010376	G020376	G030376	G020376F	G030376F	Centrale	1000	120	
G010377D	G020377D	G030377D	G020377DF	G030377DF	Posteriore DX	1000	120	
G010377S	G020377S	G030377S	G020377SF	G030377SF	Posteriore SX	1000	120	

G010378D	G020378D	G030378D	G020378DF	G030378DF	Anteriore DX	1100	85	
G010378S	G020378S	G030378S	G020378SF	G030378SF	Anteriore SX	1100	85	
G010379D	G020379D	G030379D	G020379DF	G030379DF	Anteriore DX	1100	120	
G010379S	G020379S	G030379S	G020379SF	G030379SF	Anteriore SX	1100	120	
G010380	G020380	G030380	G020380F	G030380F	Centrale	1100	120	
G010381D	G020381D	G030381D	G020381DF	G030381DF	Posteriore DX	1100	120	
G010381S	G020381S	G030381S	G020381SF	G030381SF	Posteriore SX	1100	120	



S.P. 231 (Ex S.S. 98) Km. 79+850 - 70026 MODUGNO (BA)  
<http://www.cmvisrl.com> - email: [info@cmvisrl.com](mailto:info@cmvisrl.com)  
 Tel.: 080 - 5358899 - Fax: 080 - 5358909  
 P.IVA: 05329520729

SOVRAMONTANTI

SOVRAMONTANTE A LEVA RIBALTABILE

**SPESSORE mm 41**

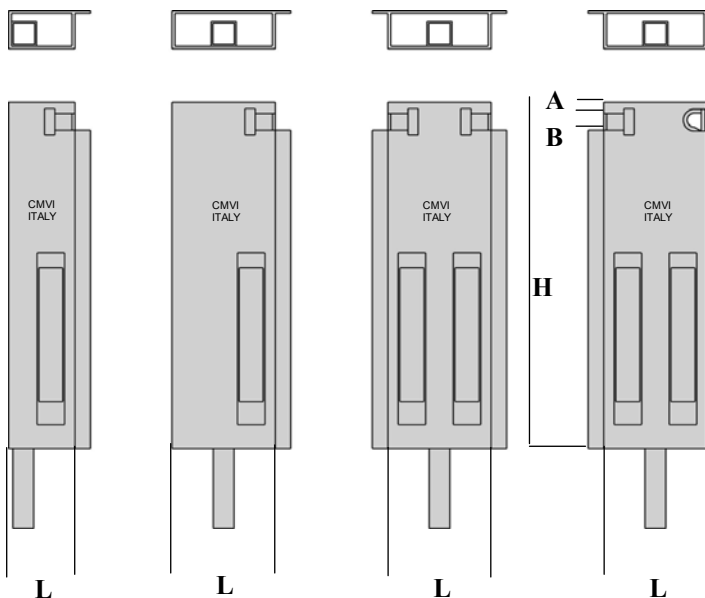

**Caratteristiche Tecniche**

A	B				
13	30				

FERRO	INOX 304 PARZIALE	INOX 304 TOTALE	INOX 304 P. FIORET.	INOX 304 T. FIORET.				
CODICE	CODICE	CODICE	CODICE	CODICE	DESCRIZIONE	H.	L.	PESO gr
G040350D	G050350D	G060350D	G050350DF	G060350DF	Anteriore DX	400	85	
G040350S	G050350S	G060350S	G050350SF	G060350SF	Anteriore SX	400	85	
G040351D	G050351D	G060351D	G050351DF	G060351DF	Anteriore DX	400	120	
G040351S	G050351S	G060351S	G050351SF	G060351SF	Anteriore SX	400	120	
G040352	G050352	G060352	G050352F	G060352F	Centrale	400	120	
G040353D	G050353D	G060353D	G050353DF	G060353DF	Posteriore DX	400	120	
G040353S	G050353S	G060353S	G050353SF	G060353SF	Posteriore SX	400	120	

G040354D	G050354D	G060354D	G050354DF	G060354DF	Anteriore DX	500	85	
G040354S	G050354S	G060354S	G050354SF	G060354SF	Anteriore SX	500	85	
G040355D	G050355D	G060355D	G050355DF	G060355DF	Anteriore DX	500	120	
G040355S	G050355S	G060355S	G050355SF	G060355SF	Anteriore SX	500	120	
G040356	G050356	G060356	G050356F	G060356F	Centrale	500	120	
G040357D	G050357D	G060357D	G050357DF	G060357DF	Posteriore DX	500	120	
G040357S	G050357S	G060357S	G050357SF	G060357SF	Posteriore SX	500	120	



S.P. 231 (Ex S.S. 98) Km. 79+850 - 70026 MODUGNO (BA)  
<http://www.cmvisrl.com> - email: [info@cmvisrl.com](mailto:info@cmvisrl.com)  
 Tel.: 080 - 5358899 - Fax: 080 - 5358909  
 P.IVA: 05329520729

SOVRAMONTANTI

SOVRAMONTANTE A LEVA RIBALTABILE

**SPESSORE mm 41**

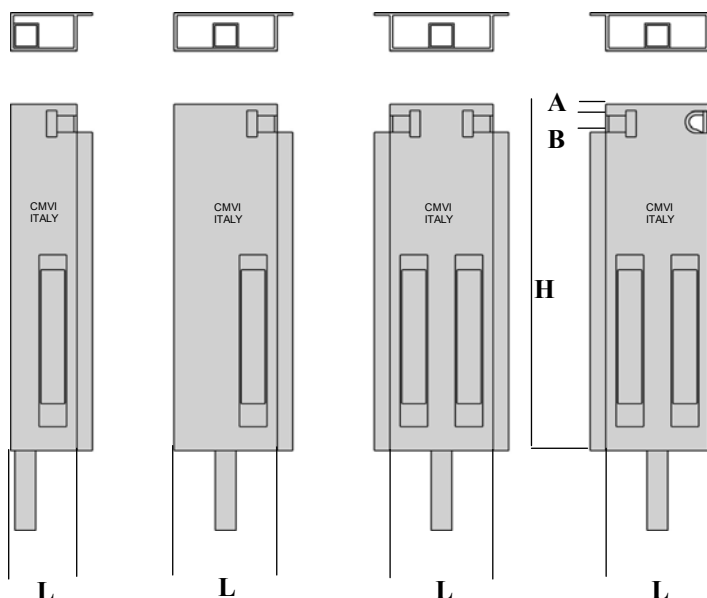

### Caratteristiche Tecniche

A	B				
13	30				

FERRO	INOX 304 PARZIALE	INOX 304 TOTALE	INOX 304 P. FIORET.	INOX 304 T. FIORET.	DESCRIZIONE	H.	L.	PESO gr
<b>G040358D</b>	<b>G050358D</b>	<b>G060358D</b>	<b>G050358DF</b>	<b>G060358DF</b>	Anteriore DX	<b>600</b>	<b>85</b>	
<b>G040358S</b>	<b>G050358S</b>	<b>G060358S</b>	<b>G050358SF</b>	<b>G060358SF</b>	Anteriore SX	<b>600</b>	<b>85</b>	
<b>G040359D</b>	<b>G050359D</b>	<b>G060359D</b>	<b>G050359DF</b>	<b>G060359DF</b>	Anteriore DX	<b>600</b>	<b>120</b>	
<b>G040359S</b>	<b>G050359S</b>	<b>G060359S</b>	<b>G050359SF</b>	<b>G060359SF</b>	Anteriore SX	<b>600</b>	<b>120</b>	
<b>G040360</b>	<b>G050360</b>	<b>G060360</b>	<b>G050360F</b>	<b>G060360F</b>	Centrale	<b>600</b>	<b>120</b>	
<b>G040361D</b>	<b>G050361D</b>	<b>G060361D</b>	<b>G050361DF</b>	<b>G060361DF</b>	Posteriore DX	<b>600</b>	<b>120</b>	
<b>G040361S</b>	<b>G050361S</b>	<b>G060361S</b>	<b>G050361SF</b>	<b>G060361SF</b>	Posteriore SX	<b>600</b>	<b>120</b>	

<b>G040362D</b>	<b>G050362D</b>	<b>G060362D</b>	<b>G050362DF</b>	<b>G060362DF</b>	Anteriore DX	<b>700</b>	<b>85</b>	
<b>G040362S</b>	<b>G050362S</b>	<b>G060362S</b>	<b>G050362SF</b>	<b>G060362SF</b>	Anteriore SX	<b>700</b>	<b>85</b>	
<b>G040363D</b>	<b>G050363D</b>	<b>G060363D</b>	<b>G050363DF</b>	<b>G060363DF</b>	Anteriore DX	<b>700</b>	<b>120</b>	
<b>G040363S</b>	<b>G050363S</b>	<b>G060363S</b>	<b>G050363SF</b>	<b>G060363SF</b>	Anteriore SX	<b>700</b>	<b>120</b>	
<b>G040364</b>	<b>G050364</b>	<b>G060364</b>	<b>G050364F</b>	<b>G060364F</b>	Centrale	<b>700</b>	<b>120</b>	
<b>G040365D</b>	<b>G050365D</b>	<b>G060365D</b>	<b>G050365DF</b>	<b>G060365DF</b>	Posteriore DX	<b>700</b>	<b>120</b>	
<b>G040365S</b>	<b>G050365S</b>	<b>G060365S</b>	<b>G050365SF</b>	<b>G060365SF</b>	Posteriore SX	<b>700</b>	<b>120</b>	



S.P. 231 (Ex S.S. 98) Km. 79+850 - 70026 MODUGNO (BA)  
<http://www.cmvisrl.com> - email: [info@cmvisrl.com](mailto:info@cmvisrl.com)  
 Tel.: 080 - 5358899 - Fax: 080 - 5358909  
 P.IVA: 05329520729

SOVRAMONTANTI

SOVRAMONTANTE A LEVA RIBALTABILE  
**SPESSORE mm 41**

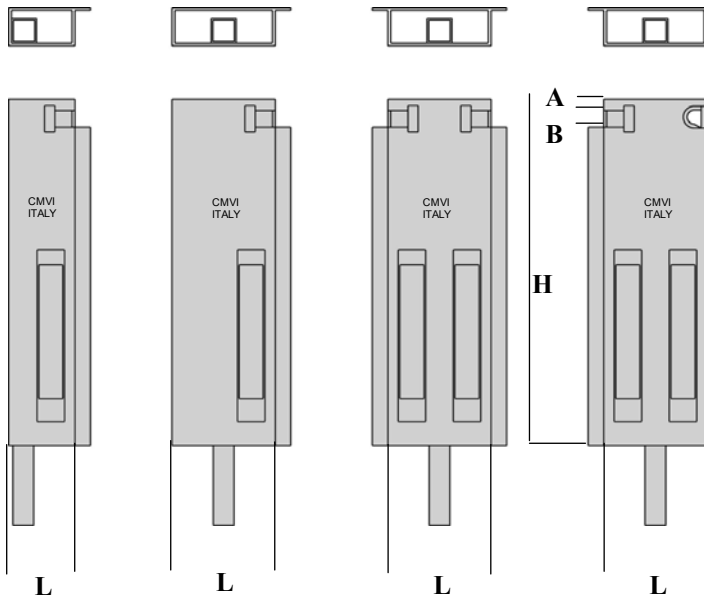

### Caratteristiche Tecniche

FERRO	INOX 304 PARZIALE	INOX 304 TOTALE	INOX 304 P. FIORET.	INOX 304 T. FIORET.	A	B			
					13	30			
CODICE	CODICE	CODICE	CODICE	CODICE	DESCRIZIONE	H.	L.	PESO gr	
G040366D	G050366D	G060366D	G050366DF	G060366DF	Anteriore DX	800	85		
G040366S	G050366S	G060366S	G050366SF	G060366SF	Anteriore SX	800	85		
G040367D	G050367D	G060367D	G050367DF	G060367DF	Anteriore DX	800	120		
G040367S	G050367S	G060367S	G050367SF	G060367SF	Anteriore SX	800	120		
G040368	G050368	G060368	G050368F	G060368F	Centrale	800	120		
G040369D	G050369D	G060369D	G050369DF	G060369DF	Posteriore DX	800	120		
G040369S	G050369S	G060369S	G050369SF	G060369SF	Posteriore SX	800	120		

G040370D	G050370D	G060370D	G050370DF	G060370DF	Anteriore DX	900	85		
G040370S	G050370S	G060370S	G050370SF	G060370SF	Anteriore SX	900	85		
G040371D	G050371D	G060371D	G050371DF	G060371DF	Anteriore DX	900	120		
G040371S	G050371S	G060371S	G050371SF	G060371SF	Anteriore SX	900	120		
G040372	G050372	G060372	G050372F	G060372F	Centrale	900	120		
G040373D	G050373D	G060373D	G050373DF	G060373DF	Posteriore DX	900	120		
G040373S	G050373S	G060373S	G050373SF	G060373SF	Posteriore SX	900	120		



S.P. 231 (Ex S.S. 98) Km. 79+850 - 70026 MODUGNO (BA)  
<http://www.cmvisrl.com> - email: [info@cmvisrl.com](mailto:info@cmvisrl.com)  
 Tel.: 080 - 5358899 - Fax: 080 - 5358909  
 P.IVA: 05329520729

SOVRAMONTANTI

SOVRAMONTANTE A LEVA RIBALTABILE  
**SPESSORE mm 41**

4 LEVE - 2 CHIUSURE

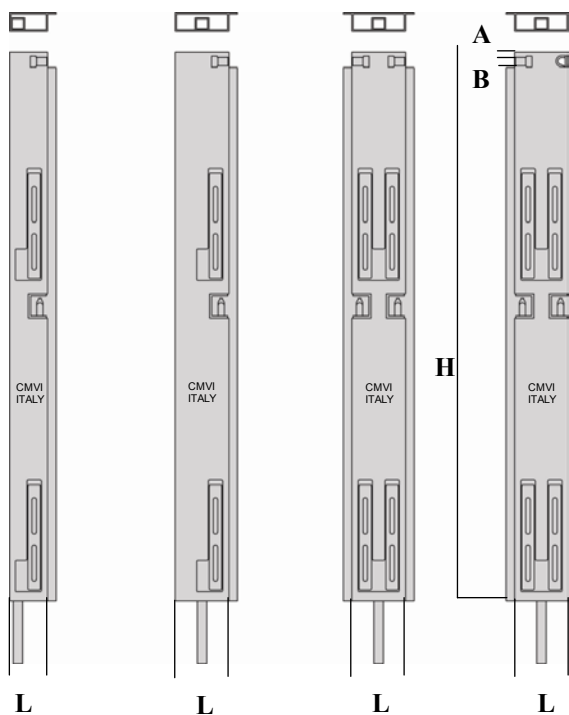

**Caratteristiche Tecniche**

A	B				
13	30				

FERRO	INOX 304 PARZIALE	INOX 304 TOTALE	INOX 304 P. FIORET.	INOX 304 T. FIORET.	DESCRIZIONE	H.	L.	PESO gr
G040374D	G050374D	G060374D	G050374DF	G060374DF	Anteriore DX	1000	85	
G040374S	G050374S	G060374S	G050374SF	G060374SF	Anteriore SX	1000	85	
G040375D	G050375D	G060375D	G050375DF	G060375DF	Anteriore DX	1000	120	
G040375S	G050375S	G060375S	G050375SF	G060375SF	Anteriore SX	1000	120	
G040376	G050376	G060376	G050376F	G060376F	Centrale	1000	120	
G040377D	G050377D	G060377D	G050377DF	G060377DF	Posteriore DX	1000	120	
G040377S	G050377S	G060377S	G050377SF	G060377SF	Posteriore SX	1000	120	

G040378D	G050378D	G060378D	G050378DF	G060378DF	Anteriore DX	1100	85	
G040378S	G050378S	G060378S	G050378SF	G060378SF	Anteriore SX	1100	85	
G040379D	G050379D	G060379D	G050379DF	G060379DF	Anteriore DX	1100	120	
G040379S	G050379S	G060379S	G050379SF	G060379SF	Anteriore SX	1100	120	
G040380	G050380	G060380	G050380F	G060380F	Centrale	1100	120	
G040381D	G050381D	G060381D	G050381DF	G060381DF	Posteriore DX	1100	120	
G040381S	G050381S	G060381S	G050381SF	G060381SF	Posteriore SX	1100	120	



S.P. 231 (Ex S.S. 98) Km. 79+850 - 70026 MODUGNO (BA)  
<http://www.cmvisrl.com> - email: [info@cmvisrl.com](mailto:info@cmvisrl.com)  
 Tel.: 080 - 5358899 - Fax: 080 - 5358909  
 P.IVA: 05329520729

SOVRAMONTANTI

SOVRAMONTANTE A LEVA RIBALTABILE  
**SPESSORE mm 41**

4 LEVE - 2 CHIUSURE

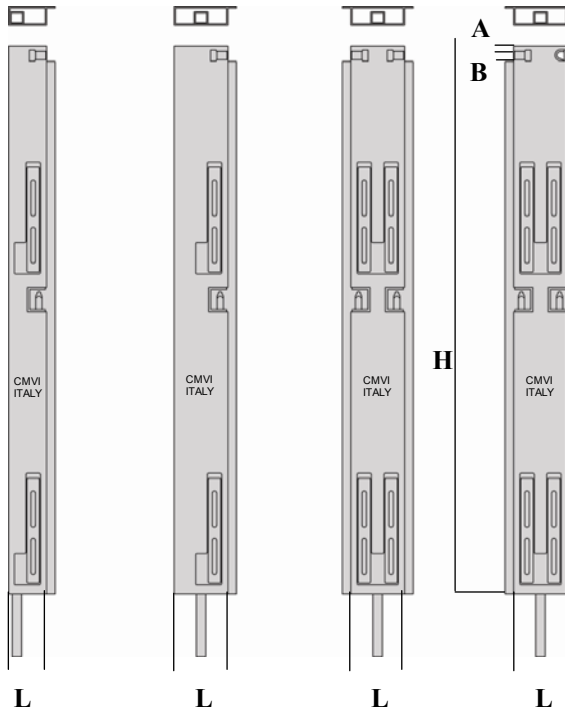

Caratteristiche Tecniche

A	B				
13	30				

FERRO	INOX 304 PARZIALE	INOX 304 TOTALE	INOX 304 P. FIORET.	INOX 304 T. FIORET.	DESCRIZIONE	H.	L.	PESO gr
<b>G040382D</b>	<b>G050382D</b>	<b>G060382D</b>	<b>G050382DF</b>	<b>G060382DF</b>	Anteriore DX	<b>1200</b>	<b>85</b>	
<b>G040382S</b>	<b>G050382S</b>	<b>G060382S</b>	<b>G050382SF</b>	<b>G060382SF</b>	Anteriore SX	<b>1200</b>	<b>85</b>	
<b>G040383D</b>	<b>G050383D</b>	<b>G060383D</b>	<b>G050383DF</b>	<b>G060383DF</b>	Anteriore DX	<b>1200</b>	<b>120</b>	
<b>G040383S</b>	<b>G050383S</b>	<b>G060383S</b>	<b>G050383SF</b>	<b>G060383SF</b>	Anteriore SX	<b>1200</b>	<b>120</b>	
<b>G040384</b>	<b>G050384</b>	<b>G060384</b>	<b>G050384F</b>	<b>G060384F</b>	Centrale	<b>1200</b>	<b>120</b>	
<b>G040385D</b>	<b>G050385D</b>	<b>G060385D</b>	<b>G050385DF</b>	<b>G060385DF</b>	Posteriore DX	<b>1200</b>	<b>120</b>	
<b>G040385S</b>	<b>G050385S</b>	<b>G060385S</b>	<b>G050385SF</b>	<b>G060385SF</b>	Posteriore SX	<b>1200</b>	<b>120</b>	



S.P. 231 (Ex S.S. 98) Km. 79+850 - 70026 MODUGNO (BA)  
<http://www.cmvisrl.com> - email: [info@cmvisrl.com](mailto:info@cmvisrl.com)  
 Tel.: 080 - 5358899 - Fax: 080 - 5358909  
 P.IVA: 05329520729

SOVRAMONTANTI

SOVRAMONTANTE A LEVA RIBALTABILE  
**SPESSORE mm 46**

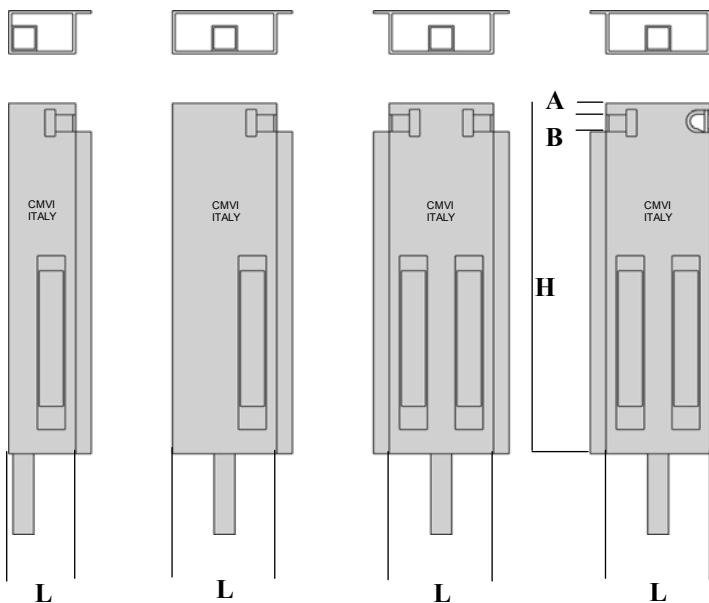

**Caratteristiche Tecniche**

A	B				
13	30				

FERRO					FERRO				
CODICE	DESCRIZIONE	H.	L.	PESO gr	CODICE	DESCRIZIONE	H.	L.	PESO gr
G070350D	Anteriore DX	400	90		G070358D	Anteriore DX	600	90	
G070350S	Anteriore SX	400	90		G070358S	Anteriore SX	600	90	
G070351D	Anteriore DX	400	120		G070359D	Anteriore DX	600	120	
G070351S	Anteriore SX	400	120		G070359S	Anteriore SX	600	120	
G070352	Centrale	400	120		G070360	Centrale	600	120	
G070353D	Posteriore DX	400	120		G070361D	Posteriore DX	600	120	
G070353S	Posteriore SX	400	120		G070361S	Posteriore SX	600	120	

G070354D	Anteriore DX	500	90						
G070354S	Anteriore SX	500	90						
G070355D	Anteriore DX	500	120						
G070355S	Anteriore SX	500	120						
G070356	Centrale	500	120						
G070357D	Posteriore DX	500	120						
G070357S	Posteriore SX	500	120						





S.P. 231 (Ex S.S. 98) Km. 79+850 - 70026 MODUGNO (BA)  
<http://www.cmvisrl.com> - email: [info@cmvisrl.com](mailto:info@cmvisrl.com)  
 Tel.: 080 - 5358899 - Fax: 080 - 5358909  
 P.IVA: 05329520729

SOVRAMONTANTI

SOVRAMONTANTE A LEVA RIBALTABILE  
**SPESSORE mm 46**

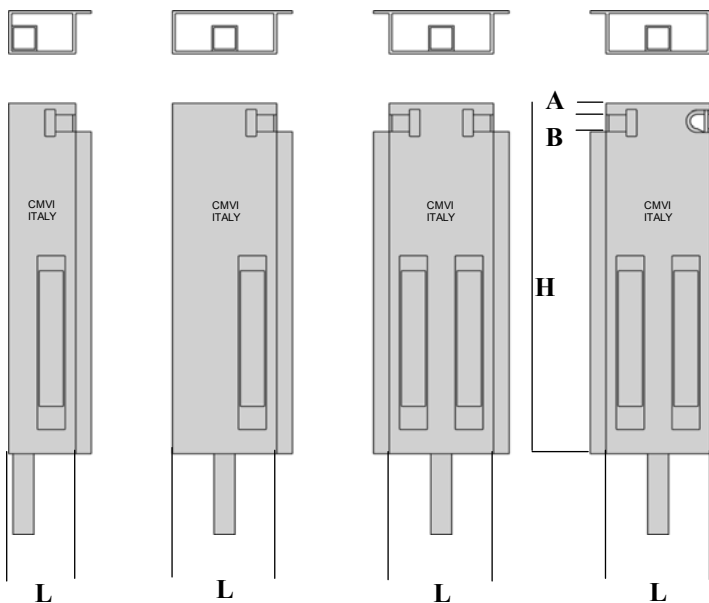

**Caratteristiche Tecniche**

A	B				
13	30				

FERRO					FERRO				
CODICE	DESCRIZIONE	H.	L.	PESO gr	CODICE	DESCRIZIONE	H.	L.	PESO gr
G070362D	Anteriore DX	700	90		G070370D	Anteriore DX	900	90	
G070362S	Anteriore SX	700	90		G070370S	Anteriore SX	900	90	
G070363D	Anteriore DX	700	120		G070371D	Anteriore DX	900	120	
G070363S	Anteriore SX	700	120		G070371S	Anteriore SX	900	120	
G070364	Centrale	700	120		G070372	Centrale	900	120	
G070365D	Posteriore DX	700	120		G070373D	Posteriore DX	900	120	
G070365S	Posteriore SX	700	120		G070373S	Posteriore SX	900	120	

G070366D	Anteriore DX	800	90						
G070366S	Anteriore SX	800	90						
G070367D	Anteriore DX	800	120						
G070367S	Anteriore SX	800	120						
G070368	Centrale	800	120						
G070369D	Posteriore DX	800	120						
G070369S	Posteriore SX	800	120						



S.P. 231 (Ex S.S. 98) Km. 79+850 - 70026 MODUGNO (BA)  
<http://www.cmvisrl.com> - email: [info@cmvisrl.com](mailto:info@cmvisrl.com)  
 Tel.: 080 - 5358899 - Fax: 080 - 5358909  
 P.IVA: 05329520729

SOVRAMONTANTI

SOVRAMONTANTE A LEVA RIBALTABILE  
**SPESSORE mm 46**

4 LEVE - 2 CHIUSURE

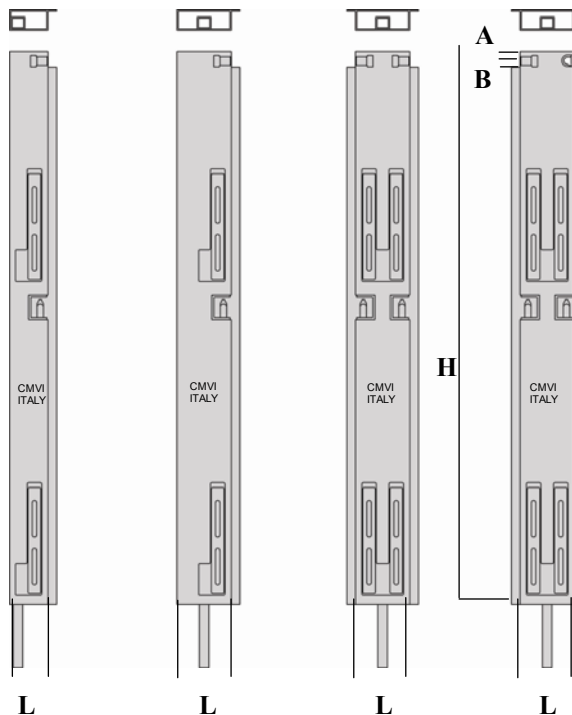

Caratteristiche Tecniche

A	B				
13	30				

FERRO					FERRO				
CODICE	DESCRIZIONE	H.	L.	PESO gr	CODICE	DESCRIZIONE	H.	L.	PESO gr
G070374D	Anteriore DX	1000	90		G070382D	Anteriore DX	1200	90	
G070374S	Anteriore SX	1000	90		G070382S	Anteriore SX	1200	90	
G070375D	Anteriore DX	1000	120		G070383D	Anteriore DX	1200	120	
G070375S	Anteriore SX	1000	120		G070383S	Anteriore SX	1200	120	
G070376	Centrale	1000	120		G070384	Centrale	1200	120	
G070377D	Posteriore DX	1000	120		G070385D	Posteriore DX	1200	120	
G070377S	Posteriore SX	1000	120		G070385S	Posteriore SX	1200	120	

G070378D	Anteriore DX	1100	90						
G070378S	Anteriore SX	1100	90						
G070379D	Anteriore DX	1100	120						
G070379S	Anteriore SX	1100	120						
G070380	Centrale	1100	120						
G070381D	Posteriore DX	1100	120						
G070381S	Posteriore SX	1100	120						



S.P. 231 (Ex S.S. 98) Km. 79+850 - 70026 MODUGNO (BA)  
 http://www.cmvisrl.com - email: info@cmvisrl.com  
 Tel.: 080 - 5358899 - Fax: 080 - 5358909  
 P.IVA: 05329520729

SOVRAMONTANTI

SOVRAMONTANTE A TRILATERALE 180°  
**SPESSORE mm 33**

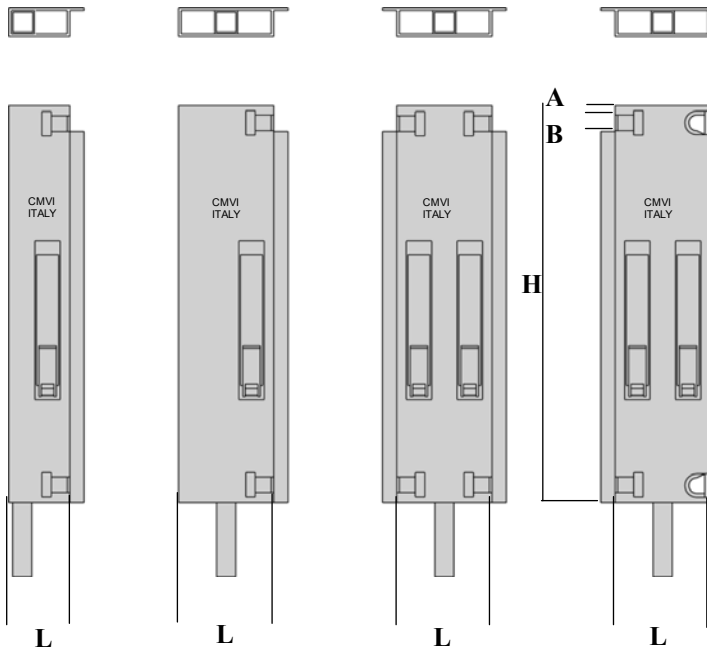

**Caratteristiche Tecniche**

A	B				
13	30				

FERRO	INOX 304 PARZIALE	INOX 304 TOTALE	INOX 304 P. FIORET.	INOX 304 T. FIORET.	DESCRIZIONE	H.	L.	PESO gr
<b>G048390D</b>	<b>G058390D</b>	<b>G068390D</b>	<b>G058390DF</b>	<b>G068390DF</b>	Anteriore DX	<b>380</b>	<b>85</b>	
<b>G048390S</b>	<b>G058390S</b>	<b>G068390S</b>	<b>G058390SF</b>	<b>G068390SF</b>	Anteriore SX	<b>380</b>	<b>85</b>	
<b>G048391D</b>	<b>G058391D</b>	<b>G068391D</b>	<b>G058391DF</b>	<b>G068391DF</b>	Anteriore DX	<b>380</b>	<b>120</b>	
<b>G048391S</b>	<b>G058391S</b>	<b>G068391S</b>	<b>G058391SF</b>	<b>G068391SF</b>	Anteriore SX	<b>380</b>	<b>120</b>	
<b>G048392</b>	<b>G058392</b>	<b>G068392</b>	<b>G058392F</b>	<b>G068392F</b>	Centrale	<b>380</b>	<b>120</b>	
<b>G048393D</b>	<b>G058393D</b>	<b>G068393D</b>	<b>G058393DF</b>	<b>G068393DF</b>	Posteriore DX	<b>380</b>	<b>120</b>	
<b>G048393S</b>	<b>G058393S</b>	<b>G068393S</b>	<b>G058393SF</b>	<b>G068393SF</b>	Posteriore SX	<b>380</b>	<b>120</b>	

<b>G048394D</b>	<b>G058394D</b>	<b>G068394D</b>	<b>G058394DF</b>	<b>G068394DF</b>	Anteriore DX	<b>480</b>	<b>85</b>	
<b>G048394S</b>	<b>G058394S</b>	<b>G068394S</b>	<b>G058394SF</b>	<b>G068394SF</b>	Anteriore SX	<b>480</b>	<b>85</b>	
<b>G048395D</b>	<b>G058395D</b>	<b>G068395D</b>	<b>G058395DF</b>	<b>G068395DF</b>	Anteriore DX	<b>480</b>	<b>120</b>	
<b>G048395S</b>	<b>G058395S</b>	<b>G068395S</b>	<b>G058395SF</b>	<b>G068395SF</b>	Anteriore SX	<b>480</b>	<b>120</b>	
<b>G048396</b>	<b>G058396</b>	<b>G068396</b>	<b>G058396F</b>	<b>G068396F</b>	Centrale	<b>480</b>	<b>120</b>	
<b>G048397D</b>	<b>G058397D</b>	<b>G068397D</b>	<b>G058397DF</b>	<b>G068397DF</b>	Posteriore DX	<b>480</b>	<b>120</b>	
<b>G048397S</b>	<b>G058397S</b>	<b>G068397S</b>	<b>G058397SF</b>	<b>G068397SF</b>	Posteriore SX	<b>480</b>	<b>120</b>	



S.P. 231 (Ex S.S. 98) Km. 79+850 - 70026 MODUGNO (BA)  
<http://www.cmvisrl.com> - email: [info@cmvisrl.com](mailto:info@cmvisrl.com)  
 Tel.: 080 - 5358899 - Fax: 080 - 5358909  
 P.IVA: 05329520729

SOVRAMONTANTI

SOVRAMONTANTE A TRILATERALE 180°  
**SPESSORE mm 33**

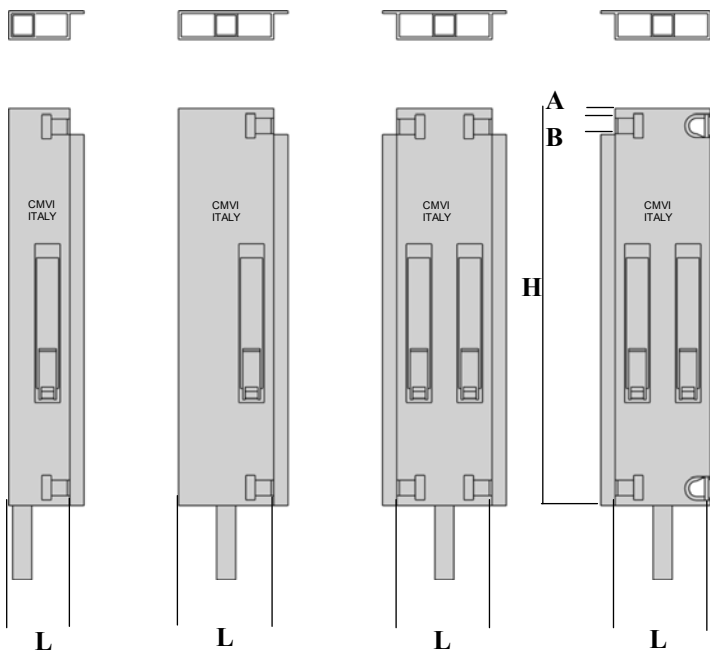

**Caratteristiche Tecniche**

A	B				
13	30				

FERRO	INOX 304 PARZIALE	INOX 304 TOTALE	INOX 304 P. FIORET.	INOX 304 T. FIORET.	DESCRIZIONE	H.	L.	PESO gr
<b>G048398D</b>	<b>G058398D</b>	<b>G068398D</b>	<b>G058398DF</b>	<b>G068398DF</b>	Anteriore DX	<b>580</b>	<b>85</b>	
<b>G048398S</b>	<b>G058398S</b>	<b>G068398S</b>	<b>G058398SF</b>	<b>G068398SF</b>	Anteriore SX	<b>580</b>	<b>85</b>	
<b>G048399D</b>	<b>G058399D</b>	<b>G068399D</b>	<b>G058399DF</b>	<b>G068399DF</b>	Anteriore DX	<b>580</b>	<b>120</b>	
<b>G048399S</b>	<b>G058399S</b>	<b>G068399S</b>	<b>G058399SF</b>	<b>G068399SF</b>	Anteriore SX	<b>580</b>	<b>120</b>	
<b>G048400</b>	<b>G058400</b>	<b>G068400</b>	<b>G058400F</b>	<b>G068400F</b>	Centrale	<b>580</b>	<b>120</b>	
<b>G048401D</b>	<b>G058401D</b>	<b>G068401D</b>	<b>G058401DF</b>	<b>G068401DF</b>	Posteriore DX	<b>580</b>	<b>120</b>	
<b>G048401S</b>	<b>G058401S</b>	<b>G068401S</b>	<b>G058401SF</b>	<b>G068401SF</b>	Posteriore SX	<b>580</b>	<b>120</b>	

<b>G048402D</b>	<b>G058402D</b>	<b>G068402D</b>	<b>G058402DF</b>	<b>G068402DF</b>	Anteriore DX	<b>680</b>	<b>85</b>	
<b>G048402S</b>	<b>G058402S</b>	<b>G068402S</b>	<b>G058402SF</b>	<b>G068402SF</b>	Anteriore SX	<b>680</b>	<b>85</b>	
<b>G048403D</b>	<b>G058403D</b>	<b>G068403D</b>	<b>G058403DF</b>	<b>G068403DF</b>	Anteriore DX	<b>680</b>	<b>120</b>	
<b>G048403S</b>	<b>G058403S</b>	<b>G068403S</b>	<b>G058403SF</b>	<b>G068403SF</b>	Anteriore SX	<b>680</b>	<b>120</b>	
<b>G048404</b>	<b>G058404</b>	<b>G068404</b>	<b>G058404F</b>	<b>G068404F</b>	Centrale	<b>680</b>	<b>120</b>	
<b>G048405D</b>	<b>G058405D</b>	<b>G068405D</b>	<b>G058405DF</b>	<b>G068405DF</b>	Posteriore DX	<b>680</b>	<b>120</b>	
<b>G048405S</b>	<b>G058405S</b>	<b>G068405S</b>	<b>G058405SF</b>	<b>G068405SF</b>	Posteriore SX	<b>680</b>	<b>120</b>	



S.P. 231 (Ex S.S. 98) Km. 79+850 - 70026 MODUGNO (BA)  
 http://www.cmvisrl.com - email: info@cmvisrl.com  
 Tel.: 080 - 5358899 - Fax: 080 - 5358909  
 P.IVA: 05329520729

SOVRAMONTANTI

SOVRAMONTANTE A TRILATERALE 180°  
**SPESSORE mm 33**

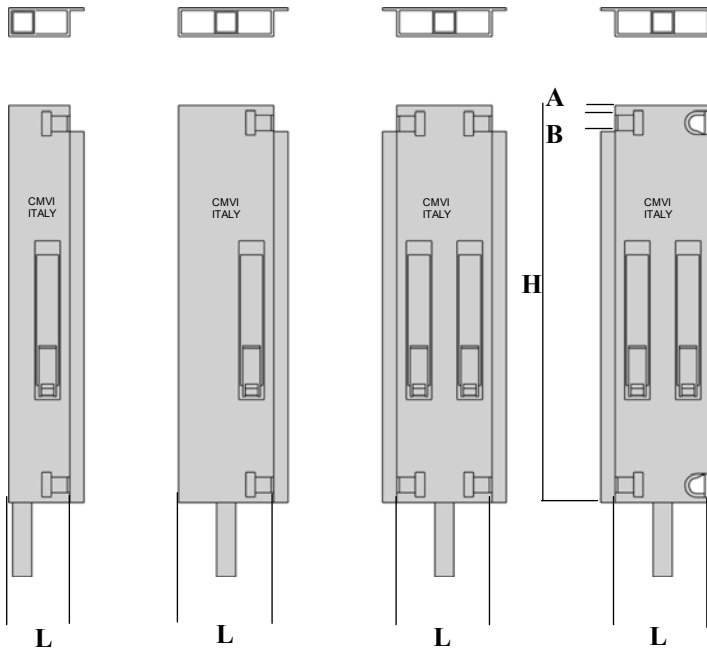

**Caratteristiche Tecniche**

A	B				
13	30				

FERRO	INOX 304 PARZIALE	INOX 304 TOTALE	INOX 304 P. FIORET.	INOX 304 T. FIORET.	DESCRIZIONE	H.	L.	PESO gr
CODICE	CODICE	CODICE	CODICE	CODICE				
G048406D	G058406D	G068406D	G058406DF	G068406DF	Anteriore DX	780	85	
G048406S	G058406S	G068406S	G058406SF	G068406SF	Anteriore SX	780	85	
G048407D	G058407D	G068407D	G058407DF	G068407DF	Anteriore DX	780	120	
G048407S	G058407S	G068407S	G058407SF	G068407SF	Anteriore SX	780	120	
G048408	G058408	G068408	G058408F	G068408F	Centrale	780	120	
G048409D	G058409D	G068409D	G058409DF	G068409DF	Posteriore DX	780	120	
G048409S	G058409S	G068409S	G058409SF	G068409SF	Posteriore SX	780	120	



S.P. 231 (Ex S.S. 98) Km. 79+850 - 70026 MODUGNO (BA)  
<http://www.cmvisrl.com> - email: [info@cmvisrl.com](mailto:info@cmvisrl.com)  
 Tel.: 080 - 5358899 - Fax: 080 - 5358909  
 P.IVA: 05329520729

**SOVRAMONTANTI**

**SOVRAMONTANTE A TRILATERALE 180°  
 SPESSORE mm 33**

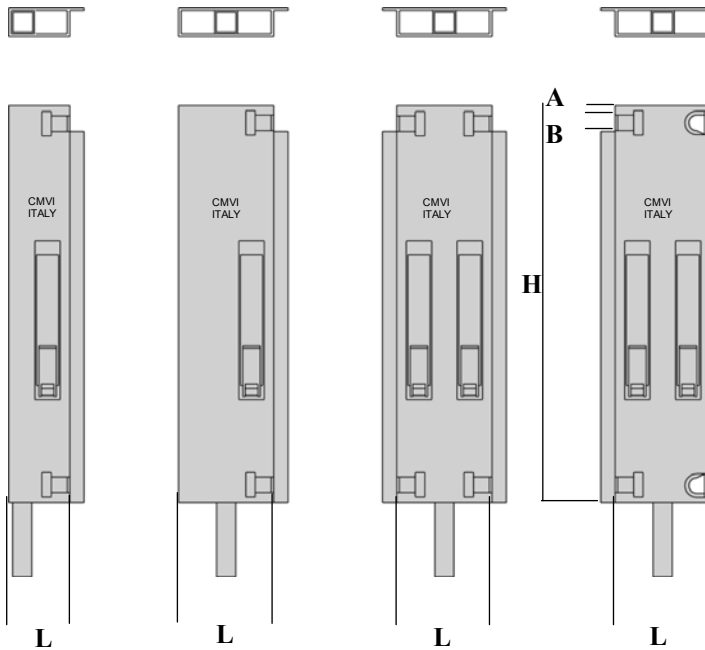

**Caratteristiche Tecniche**

A	B				
13	30				

FERRO	INOX 304 PARZIALE	INOX 304 TOTALE	INOX 304 P. FIORET.	INOX 304 T. FIORET.	DESCRIZIONE	H.	L.	PESO gr
<b>G049390D</b>	<b>G059390D</b>	<b>G069390D</b>	<b>G059390DF</b>	<b>G069390DF</b>	Anteriore DX	<b>390</b>	<b>85</b>	
<b>G049390S</b>	<b>G059390S</b>	<b>G069390S</b>	<b>G059390SF</b>	<b>G069390SF</b>	Anteriore SX	<b>390</b>	<b>85</b>	
<b>G049391D</b>	<b>G059391D</b>	<b>G069391D</b>	<b>G059391DF</b>	<b>G069391DF</b>	Anteriore DX	<b>390</b>	<b>120</b>	
<b>G049391S</b>	<b>G059391S</b>	<b>G069391S</b>	<b>G059391SF</b>	<b>G069391SF</b>	Anteriore SX	<b>390</b>	<b>120</b>	
<b>G049392</b>	<b>G059392</b>	<b>G069392</b>	<b>G059392F</b>	<b>G069392F</b>	Centrale	<b>390</b>	<b>120</b>	
<b>G049393D</b>	<b>G059393D</b>	<b>G069393D</b>	<b>G059393DF</b>	<b>G069393DF</b>	Posteriore DX	<b>390</b>	<b>120</b>	
<b>G049393S</b>	<b>G059393S</b>	<b>G069393S</b>	<b>G059393SF</b>	<b>G069393SF</b>	Posteriore SX	<b>390</b>	<b>120</b>	

<b>G049394D</b>	<b>G059394D</b>	<b>G069394D</b>	<b>G059394DF</b>	<b>G069394DF</b>	Anteriore DX	<b>490</b>	<b>85</b>	
<b>G049394S</b>	<b>G059394S</b>	<b>G069394S</b>	<b>G059394SF</b>	<b>G069394SF</b>	Anteriore SX	<b>490</b>	<b>85</b>	
<b>G049395D</b>	<b>G059395D</b>	<b>G069395D</b>	<b>G059395DF</b>	<b>G069395DF</b>	Anteriore DX	<b>490</b>	<b>120</b>	
<b>G049395S</b>	<b>G059395S</b>	<b>G069395S</b>	<b>G059395SF</b>	<b>G069395SF</b>	Anteriore SX	<b>490</b>	<b>120</b>	
<b>G049396</b>	<b>G059396</b>	<b>G069396</b>	<b>G059396F</b>	<b>G069396F</b>	Centrale	<b>490</b>	<b>120</b>	
<b>G049397D</b>	<b>G059397D</b>	<b>G069397D</b>	<b>G059397DF</b>	<b>G069397DF</b>	Posteriore DX	<b>490</b>	<b>120</b>	
<b>G049397S</b>	<b>G059397S</b>	<b>G069397S</b>	<b>G059397SF</b>	<b>G069397SF</b>	Posteriore SX	<b>490</b>	<b>120</b>	



S.P. 231 (Ex S.S. 98) Km. 79+850 - 70026 MODUGNO (BA)  
<http://www.cmvisrl.com> - email: [info@cmvisrl.com](mailto:info@cmvisrl.com)  
 Tel.: 080 - 5358899 - Fax: 080 - 5358909  
 P.IVA: 05329520729

**SOVRAMONTANTI**

**SOVRAMONTANTE A TRILATERALE 180°  
 SPESSORE mm 33**

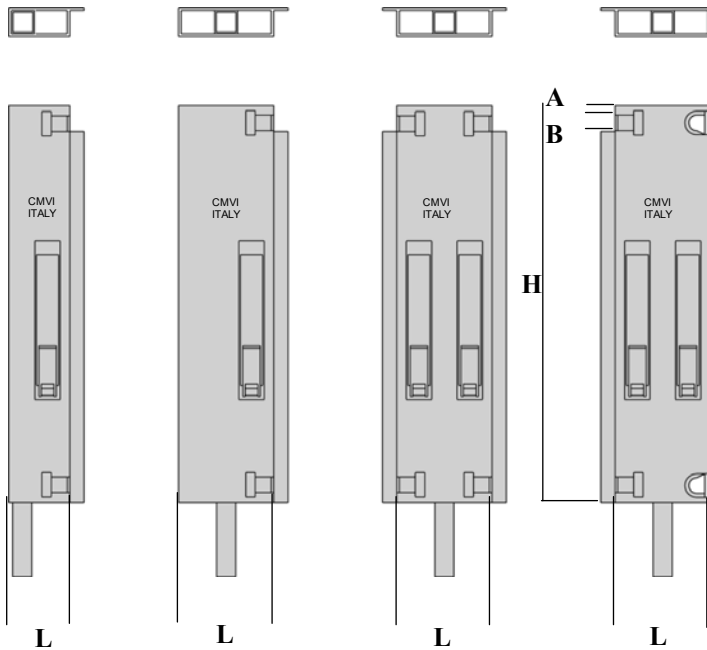

**Caratteristiche Tecniche**

A	B				
13	30				

FERRO	INOX 304 PARZIALE	INOX 304 TOTALE	INOX 304 P. FIORET.	INOX 304 T. FIORET.	DESCRIZIONE	H.	L.	PESO gr
<b>G049398D</b>	<b>G059398D</b>	<b>G069398D</b>	<b>G059398DF</b>	<b>G069398DF</b>	Anteriore DX	<b>590</b>	<b>85</b>	
<b>G049398S</b>	<b>G059398S</b>	<b>G069398S</b>	<b>G059398SF</b>	<b>G069398SF</b>	Anteriore SX	<b>590</b>	<b>85</b>	
<b>G049399D</b>	<b>G059399D</b>	<b>G069399D</b>	<b>G059399DF</b>	<b>G069399DF</b>	Anteriore DX	<b>590</b>	<b>120</b>	
<b>G049399S</b>	<b>G059399S</b>	<b>G069399S</b>	<b>G059399SF</b>	<b>G069399SF</b>	Anteriore SX	<b>590</b>	<b>120</b>	
<b>G049400</b>	<b>G059400</b>	<b>G069400</b>	<b>G059400F</b>	<b>G069400F</b>	Centrale	<b>590</b>	<b>120</b>	
<b>G049401D</b>	<b>G059401D</b>	<b>G069401D</b>	<b>G059401DF</b>	<b>G069401DF</b>	Posteriore DX	<b>590</b>	<b>120</b>	
<b>G049401S</b>	<b>G059401S</b>	<b>G069401S</b>	<b>G059401SF</b>	<b>G069401SF</b>	Posteriore SX	<b>590</b>	<b>120</b>	

<b>G049402D</b>	<b>G059402D</b>	<b>G069402D</b>	<b>G059402DF</b>	<b>G069402DF</b>	Anteriore DX	<b>690</b>	<b>85</b>	
<b>G049402S</b>	<b>G059402S</b>	<b>G069402S</b>	<b>G059402SF</b>	<b>G069402SF</b>	Anteriore SX	<b>690</b>	<b>85</b>	
<b>G049403D</b>	<b>G059403D</b>	<b>G069403D</b>	<b>G059403DF</b>	<b>G069403DF</b>	Anteriore DX	<b>690</b>	<b>120</b>	
<b>G049403S</b>	<b>G059403S</b>	<b>G069403S</b>	<b>G059403SF</b>	<b>G069403SF</b>	Anteriore SX	<b>690</b>	<b>120</b>	
<b>G049404</b>	<b>G059404</b>	<b>G069404</b>	<b>G059404F</b>	<b>G069404F</b>	Centrale	<b>690</b>	<b>120</b>	
<b>G049405D</b>	<b>G059405D</b>	<b>G069405D</b>	<b>G059405DF</b>	<b>G069405DF</b>	Posteriore DX	<b>690</b>	<b>120</b>	
<b>G049405S</b>	<b>G059405S</b>	<b>G069405S</b>	<b>G059405SF</b>	<b>G069405SF</b>	Posteriore SX	<b>690</b>	<b>120</b>	



S.P. 231 (Ex S.S. 98) Km. 79+850 - 70026 MODUGNO (BA)  
<http://www.cmvisrl.com> - email: [info@cmvisrl.com](mailto:info@cmvisrl.com)  
 Tel.: 080 - 5358899 - Fax: 080 - 5358909  
 P.IVA: 05329520729

**SOVRAMONTANTI**

**SOVRAMONTANTE A TRILATERALE 180°  
 SPESSORE mm 33**

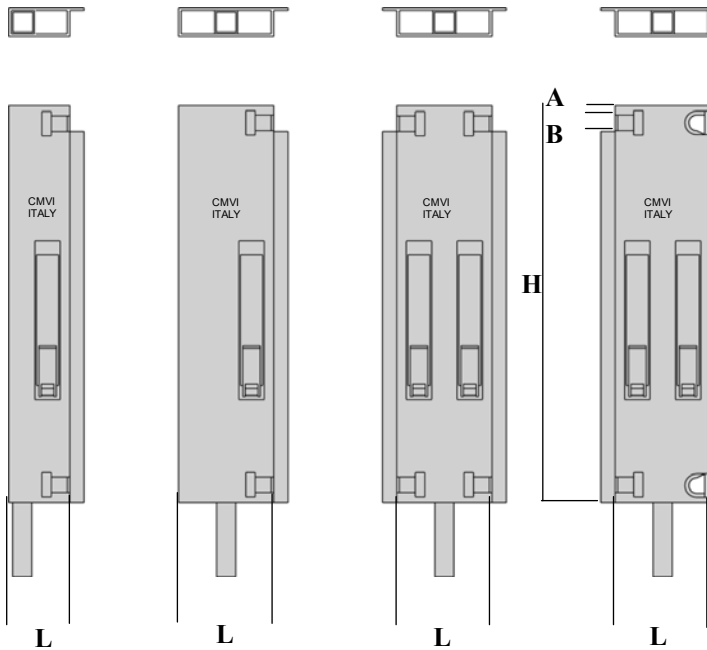

**Caratteristiche Tecniche**

A	B				
13	30				

FERRO	INOX 304 PARZIALE	INOX 304 TOTALE	INOX 304 P. FIORET.	INOX 304 T. FIORET.	DESCRIZIONE	H.	L.	PESO gr
CODICE	CODICE	CODICE	CODICE	CODICE				
G049406D	G059406D	G069406D	G059406DF	G069406DF	Anteriore DX	790	85	
G049406S	G059406S	G069406S	G059406SF	G069406SF	Anteriore SX	790	85	
G049407D	G059407D	G069407D	G059407DF	G069407DF	Anteriore DX	790	120	
G049407S	G059407S	G069407S	G059407SF	G069407SF	Anteriore SX	790	120	
G049408	G059408	G069408	G059408F	G069408F	Centrale	790	120	
G049409D	G059409D	G069409D	G059409DF	G069409DF	Posteriore DX	790	120	
G049409S	G059409S	G069409S	G059409SF	G069409SF	Posteriore SX	790	120	







S.P. 231 (Ex S.S. 98) Km. 79+850 - 70026 MODUGNO (BA)  
 http://www.cmvisrl.com - email: info@cmvisrl.com  
 Tel.: 080 - 5358899 - Fax: 080 - 5358909  
 P.IVA: 05329520729

**SOVRAMONTANTI**

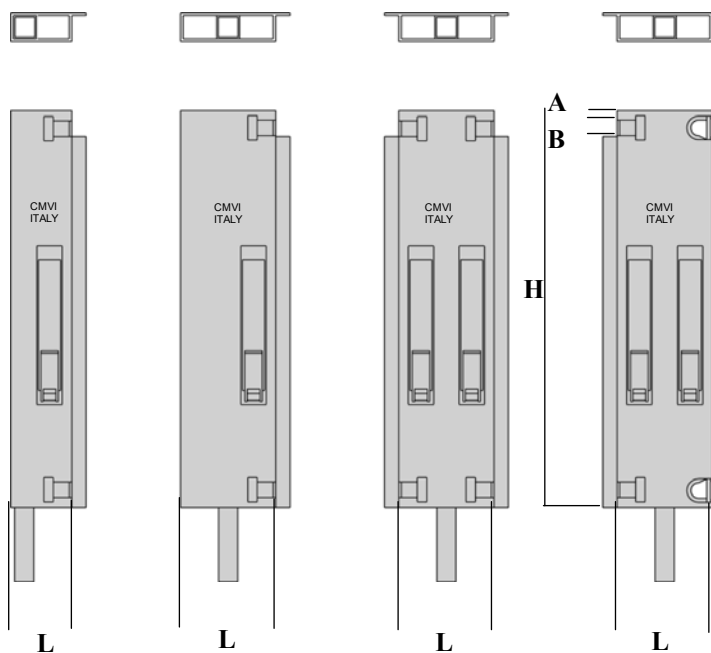
**SOVRAMONTANTE A TRILATERALE 180°  
 SPESSORE mm 33**



**Caratteristiche Tecniche**

A	B				
13	30				

FERRO	INOX 304 PARZIALE	INOX 304 TOTALE	INOX 304 P. FIORET.	INOX 304 T. FIORET.	DESCRIZIONE	H.	L.	PESO gr
<b>G050390D</b>	<b>G060390D</b>	<b>G070390D</b>	<b>G060390DF</b>	<b>G070390DF</b>	Anteriore DX	<b>400</b>	<b>85</b>	
<b>G050390S</b>	<b>G060390S</b>	<b>G070390S</b>	<b>G060390SF</b>	<b>G070390SF</b>	Anteriore SX	<b>400</b>	<b>85</b>	
<b>G050391D</b>	<b>G060391D</b>	<b>G070391D</b>	<b>G060391DF</b>	<b>G070391DF</b>	Anteriore DX	<b>400</b>	<b>120</b>	
<b>G050391S</b>	<b>G060391S</b>	<b>G070391S</b>	<b>G060391SF</b>	<b>G070391SF</b>	Anteriore SX	<b>400</b>	<b>120</b>	
<b>G050392</b>	<b>G060392</b>	<b>G070392</b>	<b>G060392F</b>	<b>G070392F</b>	Centrale	<b>400</b>	<b>120</b>	
<b>G050393D</b>	<b>G060393D</b>	<b>G070393D</b>	<b>G060393DF</b>	<b>G070393DF</b>	Posteriore DX	<b>400</b>	<b>120</b>	
<b>G050393S</b>	<b>G060393S</b>	<b>G070393S</b>	<b>G060393SF</b>	<b>G070393SF</b>	Posteriore SX	<b>400</b>	<b>120</b>	

<b>G050394D</b>	<b>G060394D</b>	<b>G070394D</b>	<b>G060394DF</b>	<b>G070394DF</b>	Anteriore DX	<b>500</b>	<b>85</b>	
<b>G050394S</b>	<b>G060394S</b>	<b>G070394S</b>	<b>G060394SF</b>	<b>G070394SF</b>	Anteriore SX	<b>500</b>	<b>85</b>	
<b>G050395D</b>	<b>G060395D</b>	<b>G070395D</b>	<b>G060395DF</b>	<b>G070395DF</b>	Anteriore DX	<b>500</b>	<b>120</b>	
<b>G050395S</b>	<b>G060395S</b>	<b>G070395S</b>	<b>G060395SF</b>	<b>G070395SF</b>	Anteriore SX	<b>500</b>	<b>120</b>	
<b>G050396</b>	<b>G060396</b>	<b>G070396</b>	<b>G060396F</b>	<b>G070396F</b>	Centrale	<b>500</b>	<b>120</b>	
<b>G050397D</b>	<b>G060397D</b>	<b>G070397D</b>	<b>G060397DF</b>	<b>G070397DF</b>	Posteriore DX	<b>500</b>	<b>120</b>	
<b>G050397S</b>	<b>G060397S</b>	<b>G070397S</b>	<b>G060397SF</b>	<b>G070397SF</b>	Posteriore SX	<b>500</b>	<b>120</b>	



S.P. 231 (Ex S.S. 98) Km. 79+850 - 70026 MODUGNO (BA)  
 http://www.cmvisrl.com - email: info@cmvisrl.com  
 Tel.: 080 - 5358899 - Fax: 080 - 5358909  
 P.IVA: 05329520729

**SOVRAMONTANTI**

**SOVRAMONTANTE A TRILATERALE 180°  
 SPESSORE mm 33**

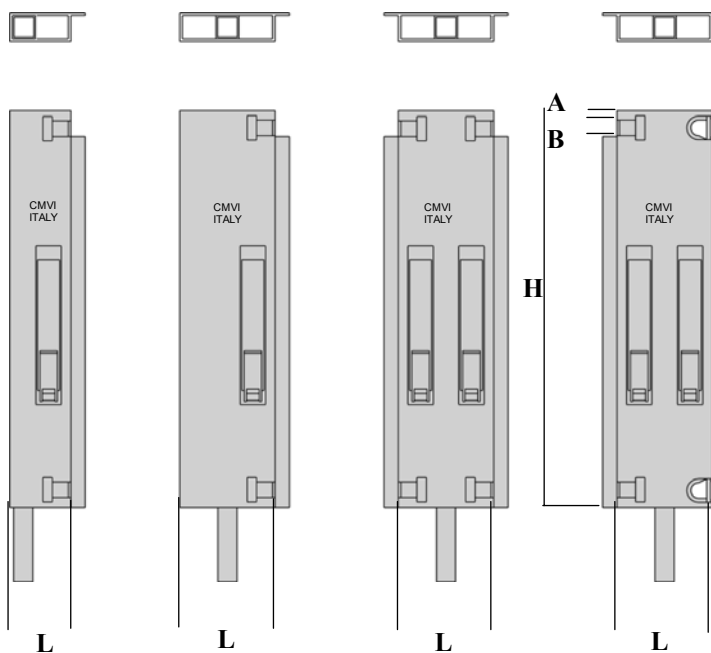

**Caratteristiche Tecniche**

A	B				
13	30				

FERRO	INOX 304 PARZIALE	INOX 304 TOTALE	INOX 304 P. FIORET.	INOX 304 T. FIORET.	DESCRIZIONE	H.	L.	PESO gr
G050398D	G060398D	G070398D	G060398DF	G070398DF	Anteriore DX	600	85	
G050398S	G060398S	G070398S	G060398SF	G070398SF	Anteriore SX	600	85	
G050399D	G060399D	G070399D	G060399DF	G070399DF	Anteriore DX	600	120	
G050399S	G060399S	G070399S	G060399SF	G070399SF	Anteriore SX	600	120	
G050400	G060400	G070400	G060400F	G070400F	Centrale	600	120	
G050401D	G060401D	G070401D	G060401DF	G070401DF	Posteriore DX	600	120	
G050401S	G060401S	G070401S	G060401SF	G070401SF	Posteriore SX	600	120	

G050402D	G060402D	G070402D	G060402DF	G070402DF	Anteriore DX	700	85	
G050402S	G060402S	G070402S	G060402SF	G070402SF	Anteriore SX	700	85	
G050403D	G060403D	G070403D	G060403DF	G070403DF	Anteriore DX	700	120	
G050403S	G060403S	G070403S	G060403SF	G070403SF	Anteriore SX	700	120	
G050404	G060404	G070404	G060404F	G070404F	Centrale	700	120	
G050405D	G060405D	G070405D	G060405DF	G070405DF	Posteriore DX	700	120	
G050405S	G060405S	G070405S	G060405SF	G070405SF	Posteriore SX	700	120	



S.P. 231 (Ex S.S. 98) Km. 79+850 - 70026 MODUGNO (BA)  
 http://www.cmvisrl.com - email: info@cmvisrl.com  
 Tel.: 080 - 5358899 - Fax: 080 - 5358909  
 P.IVA: 05329520729

SOVRAMONTANTI

SOVRAMONTANTE A TRILATERALE 180°  
**SPESORE mm 33**

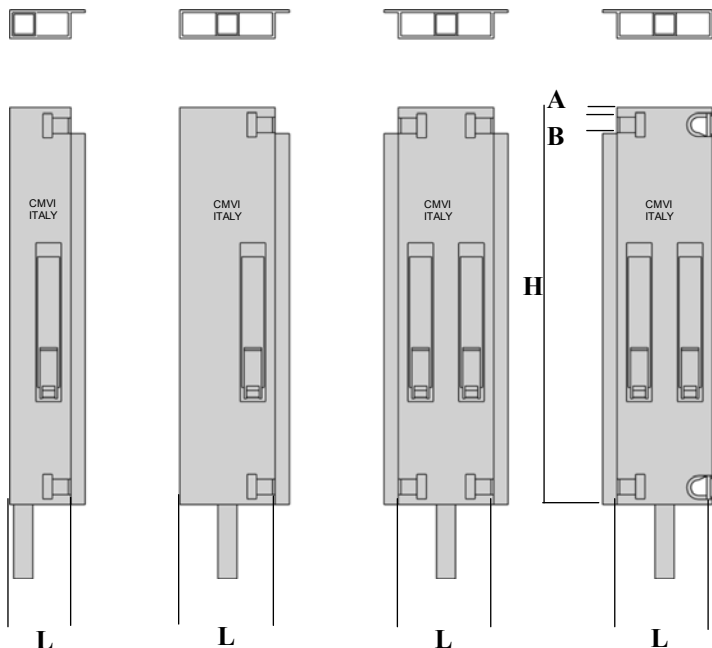

**Caratteristiche Tecniche**

A	B				
13	30				

FERRO	INOX 304 PARZIALE	INOX 304 TOTALE	INOX 304 P. FIORET.	INOX 304 T. FIORET.	DESCRIZIONE	H.	L.	PESO gr
<b>G050406D</b>	<b>G060406D</b>	<b>G070406D</b>	<b>G060406DF</b>	<b>G070406DF</b>	Anteriore DX	<b>800</b>	<b>85</b>	
<b>G050406S</b>	<b>G060406S</b>	<b>G070406S</b>	<b>G060406SF</b>	<b>G070406SF</b>	Anteriore SX	<b>800</b>	<b>85</b>	
<b>G050407D</b>	<b>G060407D</b>	<b>G070407D</b>	<b>G060407DF</b>	<b>G070407DF</b>	Anteriore DX	<b>800</b>	<b>120</b>	
<b>G050407S</b>	<b>G060407S</b>	<b>G070407S</b>	<b>G060407SF</b>	<b>G070407SF</b>	Anteriore SX	<b>800</b>	<b>120</b>	
<b>G050408</b>	<b>G060408</b>	<b>G070408</b>	<b>G060408F</b>	<b>G070408F</b>	Centrale	<b>800</b>	<b>120</b>	
<b>G050409D</b>	<b>G060409D</b>	<b>G070409D</b>	<b>G060409DF</b>	<b>G070409DF</b>	Posteriore DX	<b>800</b>	<b>120</b>	
<b>G050409S</b>	<b>G060409S</b>	<b>G070409S</b>	<b>G060409SF</b>	<b>G070409SF</b>	Posteriore SX	<b>800</b>	<b>120</b>	

<b>G050410D</b>	<b>G060410D</b>	<b>G070410D</b>	<b>G060410DF</b>	<b>G070410DF</b>	Anteriore DX	<b>900</b>	<b>85</b>	
<b>G050410S</b>	<b>G060410S</b>	<b>G070410S</b>	<b>G060410SF</b>	<b>G070410SF</b>	Anteriore SX	<b>900</b>	<b>85</b>	
<b>G050411D</b>	<b>G060411D</b>	<b>G070411D</b>	<b>G060411DF</b>	<b>G070411DF</b>	Anteriore DX	<b>900</b>	<b>120</b>	
<b>G050411S</b>	<b>G060411S</b>	<b>G070411S</b>	<b>G060411SF</b>	<b>G070411SF</b>	Anteriore SX	<b>900</b>	<b>120</b>	
<b>G050412</b>	<b>G060412</b>	<b>G070412</b>	<b>G060412F</b>	<b>G070412F</b>	Centrale	<b>900</b>	<b>120</b>	
<b>G050413D</b>	<b>G060413D</b>	<b>G070413D</b>	<b>G060413DF</b>	<b>G070413DF</b>	Posteriore DX	<b>900</b>	<b>120</b>	
<b>G050413S</b>	<b>G060413S</b>	<b>G070413S</b>	<b>G060413SF</b>	<b>G070413SF</b>	Posteriore SX	<b>900</b>	<b>120</b>	



S.P. 231 (Ex S.S. 98) Km. 79+850 - 70026 MODUGNO (BA)  
 http://www.cmvisrl.com - email: info@cmvisrl.com  
 Tel.: 080 - 5358899 - Fax: 080 - 5358909  
 P.IVA: 05329520729

SOVRAMONTANTI

SOVRAMONTANTE A TRILATERALE 180°  
**SPESSORE mm 33**

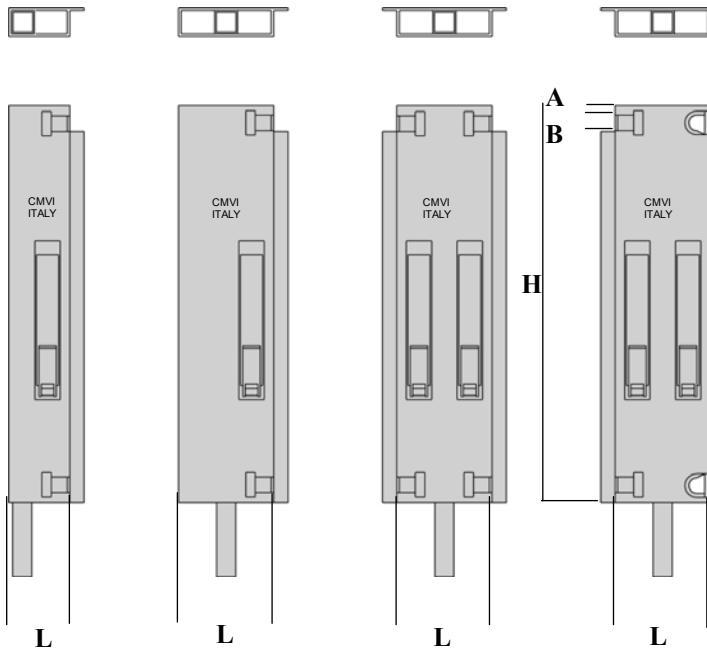

**Caratteristiche Tecniche**

A	B				
13	30				

FERRO	INOX 304 PARZIALE	INOX 304 TOTALE	INOX 304 P. FIORET.	INOX 304 T. FIORET.	DESCRIZIONE	H.	L.	PESO gr
CODICE	CODICE	CODICE	CODICE	CODICE				
G050414D	G060414D	G070414D	G060414DF	G070414DF	Anteriore DX	1000	85	
G050414S	G060414S	G070414S	G060414SF	G070414SF	Anteriore SX	1000	85	
G050415D	G060415D	G070415D	G060415DF	G070415DF	Anteriore DX	1000	120	
G050415S	G060415S	G070415S	G060415SF	G070415SF	Anteriore SX	1000	120	
G050416	G060416	G070416	G060416F	G070416F	Centrale	1000	120	
G050417D	G060417D	G070417D	G060417DF	G070417DF	Posteriore DX	1000	120	
G050417S	G060417S	G070417S	G060417SF	G070417SF	Posteriore SX	1000	120	

G050418D	G060418D	G070418D	G060418DF	G070418DF	Anteriore DX	1100	85	
G050418S	G060418S	G070418S	G060418SF	G070418SF	Anteriore SX	1100	85	
G050419D	G060419D	G070419D	G060419DF	G070419DF	Anteriore DX	1100	120	
G050419S	G060419S	G070419S	G060419SF	G070419SF	Anteriore SX	1100	120	
G050420	G060420	G070420	G060420F	G070420F	Centrale	1100	120	
G050421D	G060421D	G070421D	G060421DF	G070421DF	Posteriore DX	1100	120	
G050421S	G060421S	G070421S	G060421SF	G070421SF	Posteriore SX	1100	120	



S.P. 231 (Ex S.S. 98) Km. 79+850 - 70026 MODUGNO (BA)  
 http://www.cmvisrl.com - email: info@cmvisrl.com  
 Tel.: 080 - 5358899 - Fax: 080 - 5358909  
 P.IVA: 05329520729

**SOVRAMONTANTI**

**SOVRAMONTANTE A TRILATERALE 180°  
 SPESSORE mm 33**

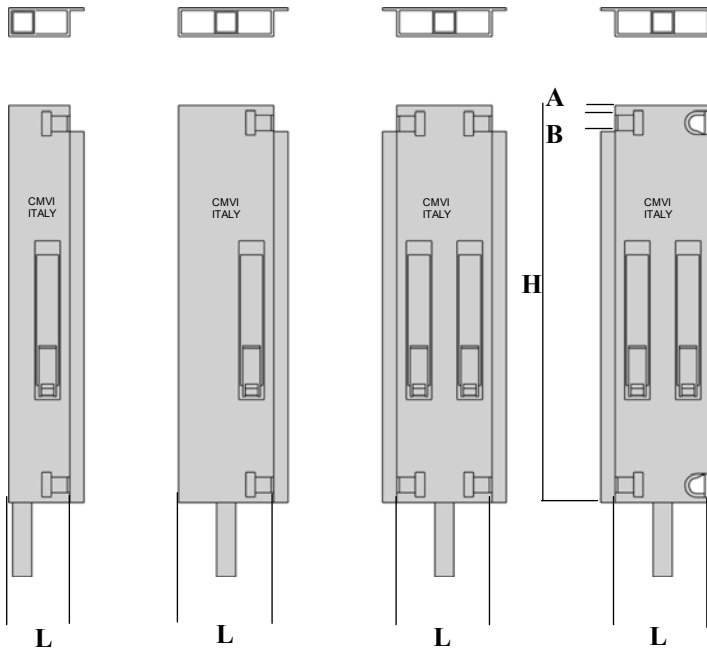

**Caratteristiche Tecniche**

A	B				
13	30				

FERRO	INOX 304 PARZIALE	INOX 304 TOTALE	INOX 304 P. FIORET.	INOX 304 T. FIORET.	DESCRIZIONE	H.	L.	PESO gr
<b>G050422D</b>	<b>G060422D</b>	<b>G070422D</b>	<b>G060422DF</b>	<b>G070422DF</b>	Anteriore DX	<b>1200</b>	<b>85</b>	
<b>G050422S</b>	<b>G060422S</b>	<b>G070422S</b>	<b>G060422SF</b>	<b>G070422SF</b>	Anteriore SX	<b>1200</b>	<b>85</b>	
<b>G050423D</b>	<b>G060423D</b>	<b>G070423D</b>	<b>G060423DF</b>	<b>G070423DF</b>	Anteriore DX	<b>1200</b>	<b>120</b>	
<b>G050423S</b>	<b>G060423S</b>	<b>G070423S</b>	<b>G060423SF</b>	<b>G070423SF</b>	Anteriore SX	<b>1200</b>	<b>120</b>	
<b>G050424</b>	<b>G060424</b>	<b>G070424</b>	<b>G060424F</b>	<b>G070424F</b>	Centrale	<b>1200</b>	<b>120</b>	
<b>G050425D</b>	<b>G060425D</b>	<b>G070425D</b>	<b>G060425DF</b>	<b>G070425DF</b>	Posteriore DX	<b>1200</b>	<b>120</b>	
<b>G050425S</b>	<b>G060425S</b>	<b>G070425S</b>	<b>G060425SF</b>	<b>G070425SF</b>	Posteriore SX	<b>1200</b>	<b>120</b>	



S.P. 231 (Ex S.S. 98) Km. 79+850 - 70026 MODUGNO (BA)  
 http://www.cmvisrl.com - email: info@cmvisrl.com  
 Tel.: 080 - 5358899 - Fax: 080 - 5358909  
 P.IVA: 05329520729

SOVRAMONTANTI

SOVRAMONTANTE A TRILATERALE 180°  
**SPESSORE mm 41**

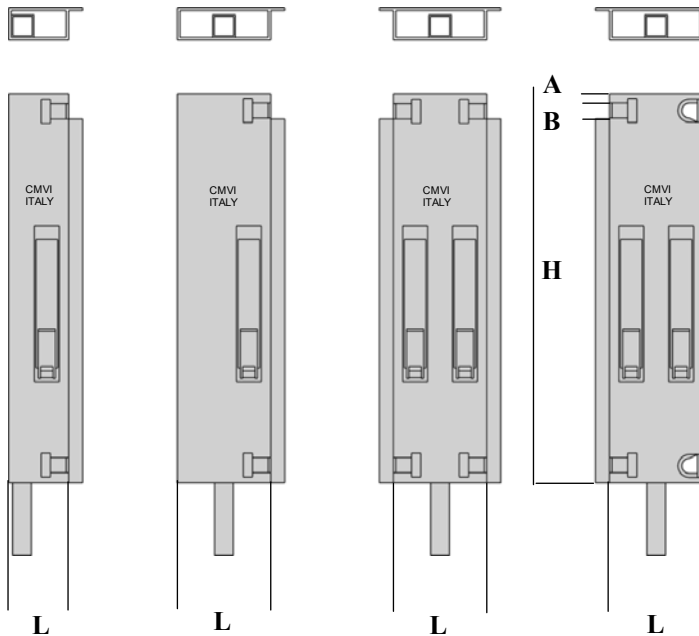

**Caratteristiche Tecniche**

A	B				
13	30				

FERRO	INOX 304 PARZIALE	INOX 304 TOTALE	INOX 304 P. FIORET.	INOX 304 T. FIORET.	DESCRIZIONE	H.	L.	PESO gr
<b>G010390D</b>	<b>G020390D</b>	<b>G030390D</b>	<b>G020390DF</b>	<b>G030390DF</b>	Anteriore DX	<b>400</b>	<b>85</b>	
<b>G010390S</b>	<b>G020390S</b>	<b>G030390S</b>	<b>G020390SF</b>	<b>G030390SF</b>	Anteriore SX	<b>400</b>	<b>85</b>	
<b>G010391D</b>	<b>G020391D</b>	<b>G030391D</b>	<b>G020391DF</b>	<b>G030391DF</b>	Anteriore DX	<b>400</b>	<b>120</b>	
<b>G010391S</b>	<b>G020391S</b>	<b>G030391S</b>	<b>G020391SF</b>	<b>G030391SF</b>	Anteriore SX	<b>400</b>	<b>120</b>	
<b>G010392</b>	<b>G020392</b>	<b>G030392</b>	<b>G020392F</b>	<b>G030392F</b>	Centrale	<b>400</b>	<b>120</b>	
<b>G010393D</b>	<b>G020393D</b>	<b>G030393D</b>	<b>G020393DF</b>	<b>G030393DF</b>	Posteriore DX	<b>400</b>	<b>120</b>	
<b>G010393S</b>	<b>G020393S</b>	<b>G030393S</b>	<b>G020393SF</b>	<b>G030393SF</b>	Posteriore SX	<b>400</b>	<b>120</b>	

<b>G010394D</b>	<b>G020394D</b>	<b>G030394D</b>	<b>G020394DF</b>	<b>G030394DF</b>	Anteriore DX	<b>500</b>	<b>85</b>	
<b>G010394S</b>	<b>G020394S</b>	<b>G030394S</b>	<b>G020394SF</b>	<b>G030394SF</b>	Anteriore SX	<b>500</b>	<b>85</b>	
<b>G010395D</b>	<b>G020395D</b>	<b>G030395D</b>	<b>G020395DF</b>	<b>G030395DF</b>	Anteriore DX	<b>500</b>	<b>120</b>	
<b>G010395S</b>	<b>G020395S</b>	<b>G030395S</b>	<b>G020395SF</b>	<b>G030395SF</b>	Anteriore SX	<b>500</b>	<b>120</b>	
<b>G010396</b>	<b>G020396</b>	<b>G030396</b>	<b>G020396F</b>	<b>G030396F</b>	Centrale	<b>500</b>	<b>120</b>	
<b>G010397D</b>	<b>G020397D</b>	<b>G030397D</b>	<b>G020397DF</b>	<b>G030397DF</b>	Posteriore DX	<b>500</b>	<b>120</b>	
<b>G010397S</b>	<b>G020397S</b>	<b>G030397S</b>	<b>G020397SF</b>	<b>G030397SF</b>	Posteriore SX	<b>500</b>	<b>120</b>	